

DIGITAL LED STRIP LIGHT

SPI and DMX512

Shenzhen Bylen Tech Co.,LTD

Tel: 0086 0755 23000864
Fax: 0086 0755 23000864
Web: www.bylentech.com
Email: info@bylentech.com

Address:5/F, Block 16th, ZhongpengChen Industrial Park, Zhenxin Road, Matian Street,
Guangming District, Shenzhen

Factory Address: 3F, Block 3B, NO13 Tianxin Road, XinTian Villiage,Huangjiang Street
Dongguan, Guangdong

2025 Catalogue

InBylen®

Work to make your future bright



Who Are We ?



Shenzhen Bylen Tech Co.,Ltd was found in 2019, we are engaging in research, production and sales in led signage industry. Our product is mainly LED signage module, LED strip light, LED Linear light, LED driver and LED controller. With our products we will offer the full solution for projects, such as 0-10V dimming, DMX, Dali, and RF dimming.

We have R&D team and sales team who have more than ten years experience in led lighting industry. We are confident to serve our customer in all over the world. Until now our products have been exported to Europe, American, Japan, and Russia.

Our Company is high-tech enterprise which have got ISO:9001 certificate and we also own a lot of product design patent. Our product is CE, UL and PSE approval that can meet most customers requests.

We have three pcs SMT machine and more than ten pcs injection machine. Now we have 50 workers and each month, there are thousands of module and strip that was finished. And we also think to expand our plant to meet more production ability.

We are developing more and more new product and look forward to have business cooperation with you in future soon.

Certificates



Factory Photo

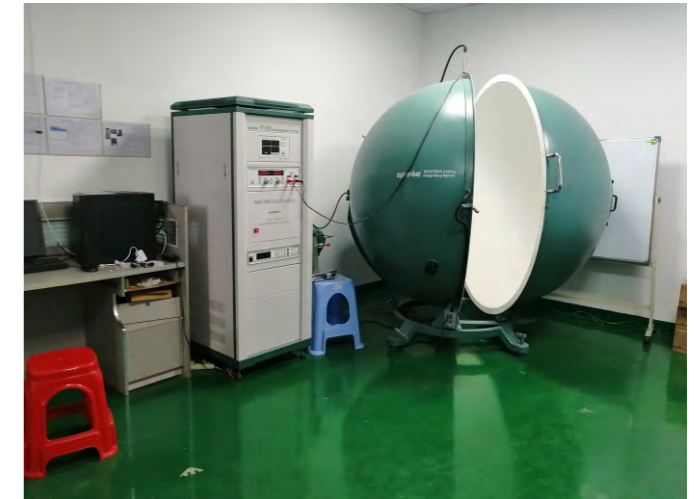

DIGITAL LED STRIP LIGHT



External IC, one IC is controlled separately as one pixel in running strip light.

VCC: 5V, 12V, 24V is optional
DI: main data Input
BI: sub data input
GND: the Ground

Unlike normal strip light, the digital strip will run as arrow direction. It will not work if reverse

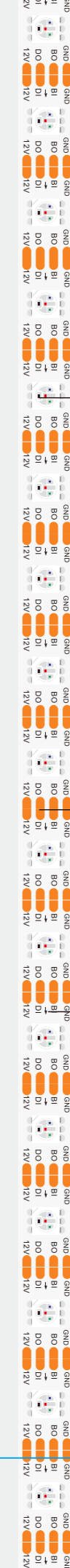
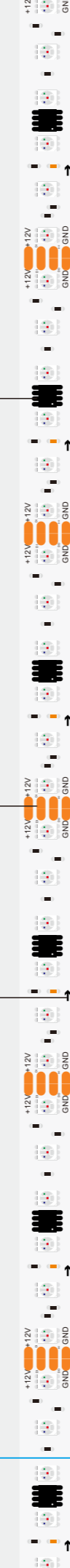

Built-in IC was packed inside LED, one IC is controlled separately as one pixel in running strip light.

VCC: 5V, 12V, 24V is optional
DI: main data Input
BI: sub data input
GND: the Ground

Unlike normal strip light, the digital strip will run as arrow direction. It will not work if reverse

DIGITAL STRIP LIGHT SYSTEM

STRIP LIGHT SOLUTION

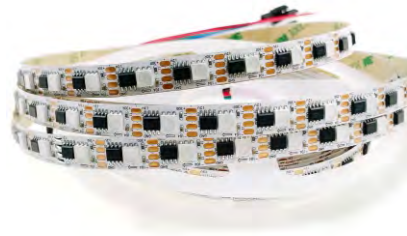

CONTROLLER SOLUTION

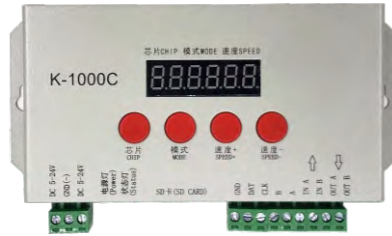

LED DRIVER SOLUTION



HOW TO CONNECT THEM?

Programmable controller

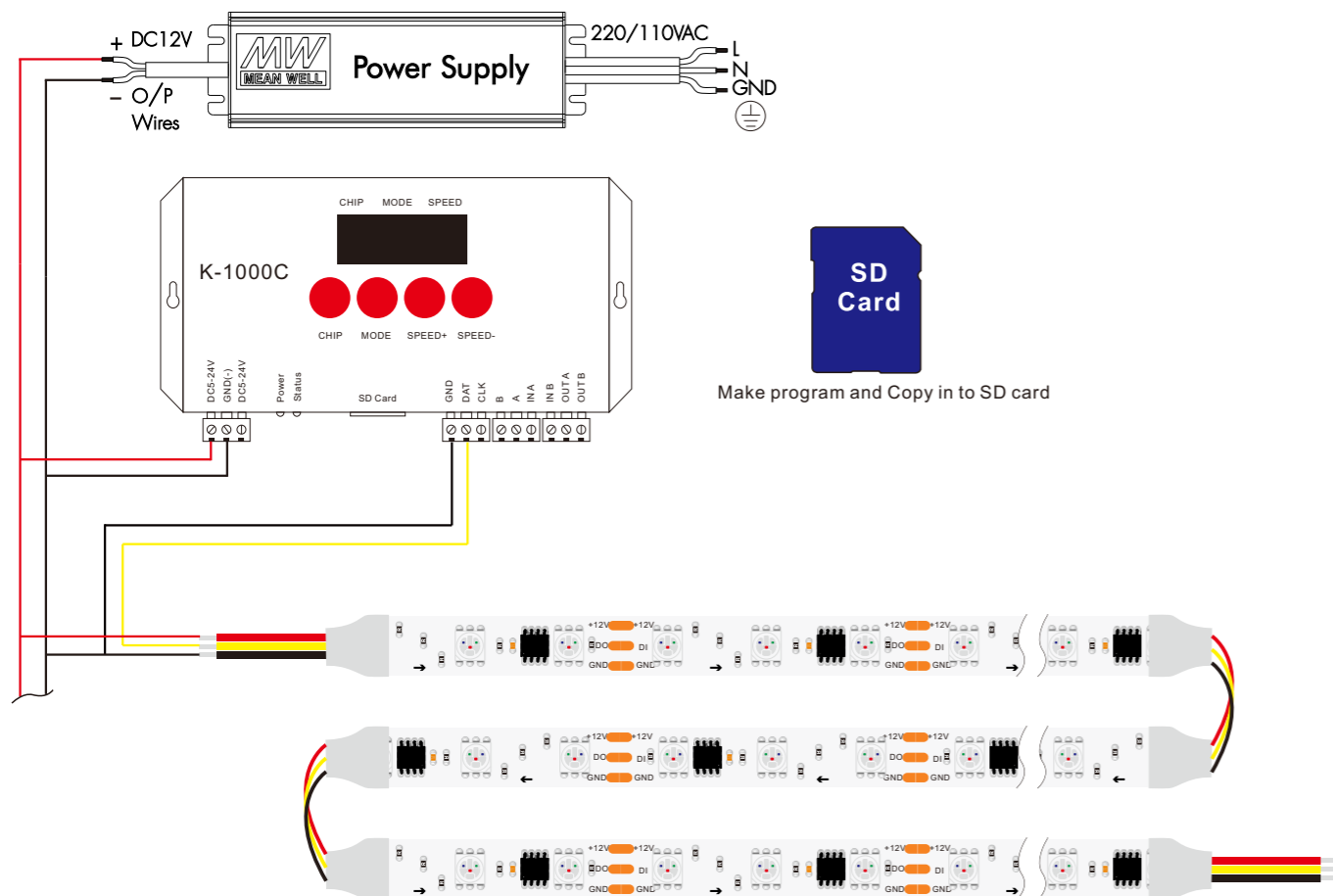

All strip in one port will be connected in series
Each 5 meter need power feed

Non-Programmable controller

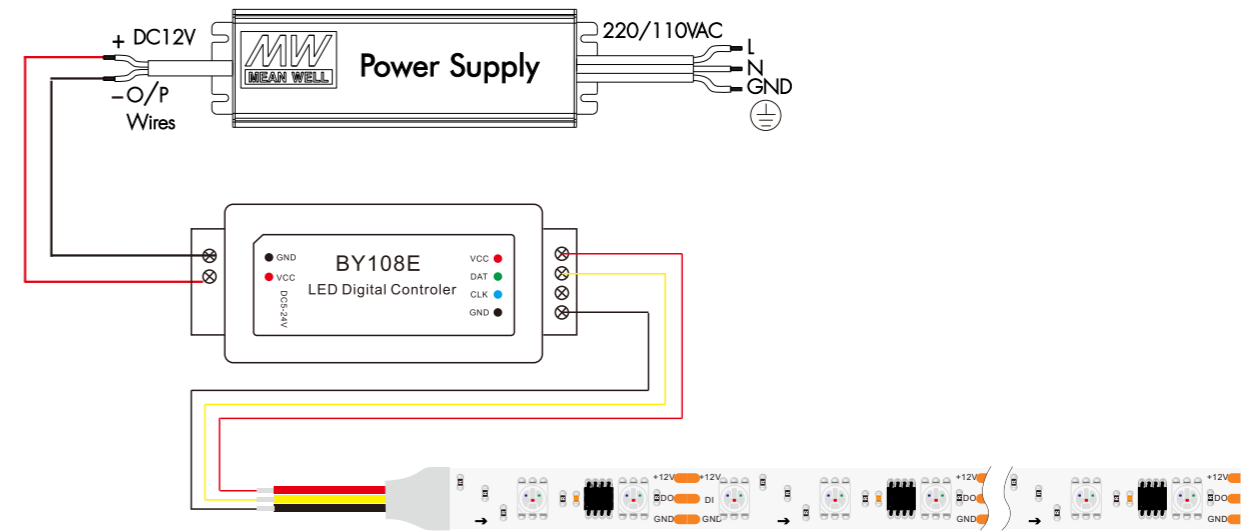

What is difference for 3lines,4 lines and 5lines?

3 lines is standard Digital SPI strip light with one signal wire. The IC is like WS2811, WS2813, SK6812, ect

4lines is digital SPI strip light with double signal wire, and there is function of break-point continues transmission. if one LED is damaged, the following led still can work, the IC like Tm1934, WS2815, Sk6813.

5line is digital DMX strip light and work with DMX512 protocol , the IC is like USC512 and TM512 ect

EXTERNAL SPI LED STRIP

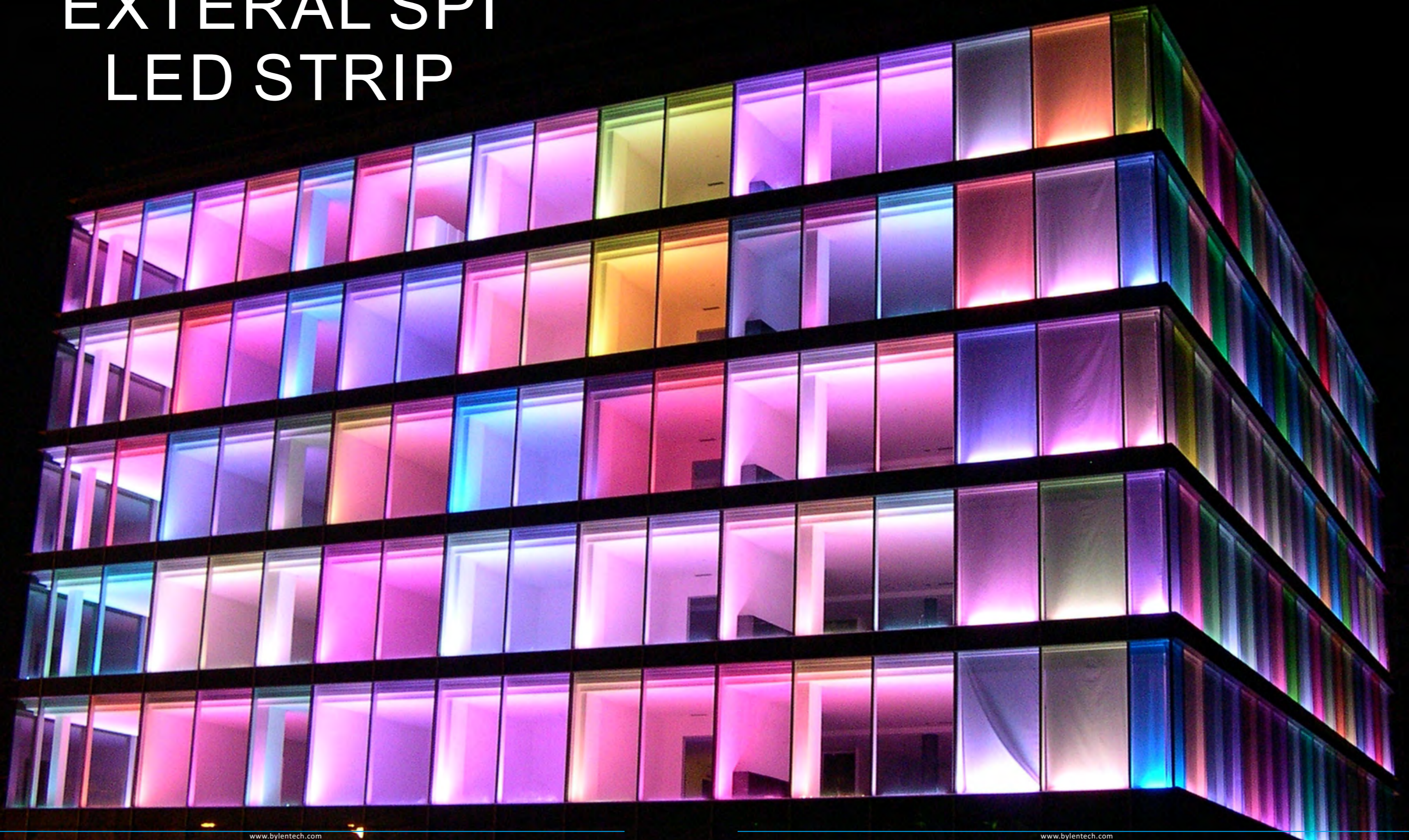

5050 WHITE COLOR 10MM 60LED DIGITAL

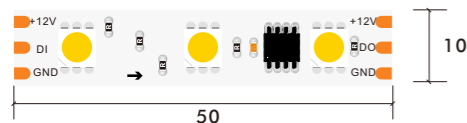
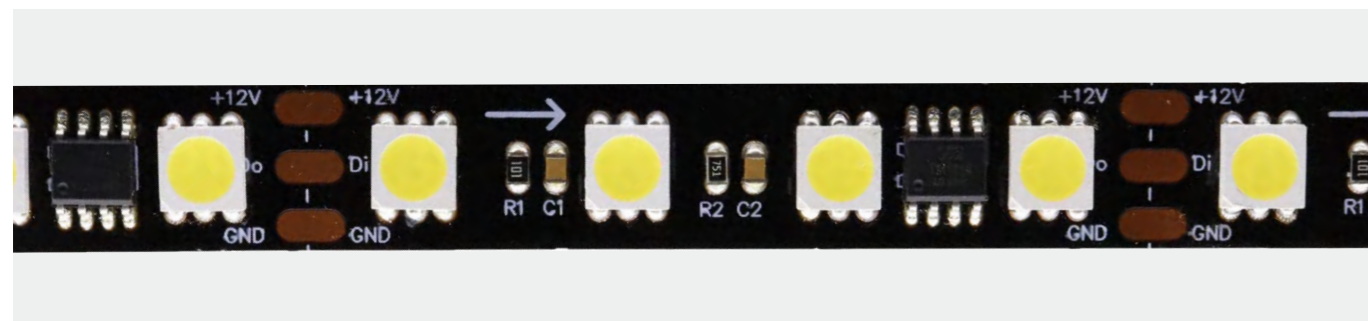

WS2811 UCS1903



12V DC 20 Pixel 3 Line 10mm 5050 60LED White Color 20pixels Digital Strip

Model Number	Voltage (dc v)	Power (w)	LED Qty (pcs)	Lumens (lm/m)	Efficacy (lm/W)	CCT&Color (K)	CRI	Cutting unit (mm)	Bean Angle (o)
S10WXX-505027-012AD-060S-MY3-3X20	12	12	60	1152	80	2700	80/90	50	120
S10WXX-505030-012AD-060S-MY3-3X20	12	12	60	1224	85	3000	80/90	50	120
S10WXX-505040-012AD-060S-MY3-3X20	12	12	60	1296	90	4000	80/90	50	120
S10WXX-505060-012AD-060S-MY3-3X20	12	12	60	1224	85	6000	80/90	50	120

*The strip light will come with 5 meters /reel
*All the data above is just for reference under IP20. it is different with IP65, IP66, IP67, IP68

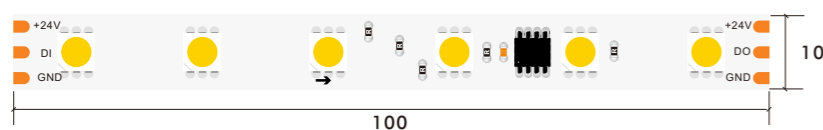

WS2811 UCS1903



24V DC 10 Pixel 3 Line 10mm 5050 60LED White Color 10pixels Digital Strip

Model Number	Voltage (dc v)	Power (w)	LED Qty (pcs)	Lumens (lm/m)	Efficacy (lm/W)	CCT&Color (K)	CRI	Cutting unit (mm)	Bean Angle (o)
S10WXX-505027-024AD-060S-MY3-3X10	24	12	60	1152	80	2700	80/90	100	120
S10WXX-505030-024AD-060S-MY3-3X10	24	12	60	1224	85	3000	80/90	100	120
S10WXX-505040-024AD-060S-MY3-3X10	24	12	60	1296	90	4000	80/90	100	120
S10WXX-505060-024AD-060S-MY3-3X10	24	12	60	1224	85	6000	80/90	100	120

*The strip light will come with 5 meter /reel
*All the data above is just for reference under Ip20. it is different with Ip65, Ip66, Ip67, IP68

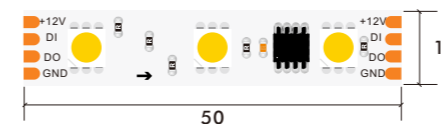

TM1934



12V DC 20 Pixel 4 Line 10mm 5050 60LED White Color 20pixels Digital Strip

Model Number	Voltage (dc v)	Power (w)	LED Qty (pcs)	Lumens (lm/m)	Efficacy (lm/W)	CCT&Color (K)	CRI	Cutting unit (mm)	Bean Angle (o)
S10WXX-505027-012AD-060S-MY3-4X20	12	12	60	1152	80	2700	80/90	50	120
S10WXX-505030-012AD-060S-MY3-4X20	12	12	60	1224	85	3000	80/90	50	120
S10WXX-505040-012AD-060S-MY3-4X20	12	12	60	1296	90	4000	80/90	50	120
S10WXX-505060-012AD-060S-MY3-4X20	12	12	60	1224	85	6000	80/90	50	120

*The strip light will come with 5 meters /reel
*All the data above is just for reference under IP20. it is different with IP65, IP66, IP67, IP68

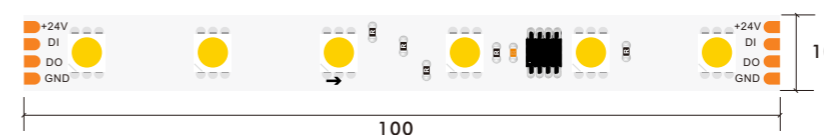

TM1934



24V DC 10 Pixel 4 Line 10mm 5050 60LED White Color 10pixels Digital Strip

Model Number	Voltage (dc v)	Power (w)	LED Qty (pcs)	Lumens (lm/m)	Efficacy (lm/W)	CCT&Color (K)	CRI	Cutting unit (mm)	Bean Angle (o)
S10WXX-505027-024AD-060S-MY3-4X10	24	12	60	1152	80	2700	80/90	100	120
S10WXX-505030-024AD-060S-MY3-4X10	24	12	60	1224	85	3000	80/90	100	120
S10WXX-505040-024AD-060S-MY3-4X10	24	12	60	1296	90	4000	80/90	100	120
S10WXX-505060-024AD-060S-MY3-4X10	24	12	60	1224	85	6000	80/90	100	120

*The strip light will come with 5 meters /reel
*All the data above is just for reference under IP20. it is different with IP65, IP66, IP67, IP68

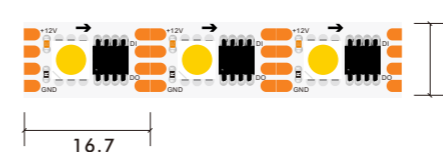

LB1908 GS8208



24V DC 60 Pixel 4 Line 10mm 5050 60LED White Color 60pixels Digital Strip

Model Number	Voltage (dc v)	Power (w)	LED Qty (pcs)	Lumens (lm/m)	Efficacy (lm/W)	CCT&Color (K)	CRI	Cutting unit (mm)	Bean Angle (o)
S10WXX-505027-024AD-060S-MY3-4X60	12	14.4	60	1152	80	2700	80/90	16.7	120
S10WXX-505030-024AD-060S-MY3-4X60	12	14.4	60	1224	85	3000	80/90	16.7	120
S10WXX-505040-024AD-060S-MY3-4X60	12	14.4	60	1296	90	4000	80/90	16.7	120
S10WXX-505060-024AD-060S-MY3-4X60	12	14.4	60	1224	85	6000	80/90	16.7	120

*The strip light will come with 5 meters /reel
*All the data above is just for reference under IP20. it is different with IP65, IP66, IP67, IP68

2835 WHITE COLOR 8 / 10MM 120LED DIGITAL STRIP

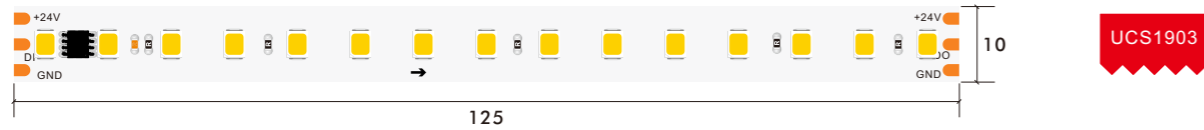
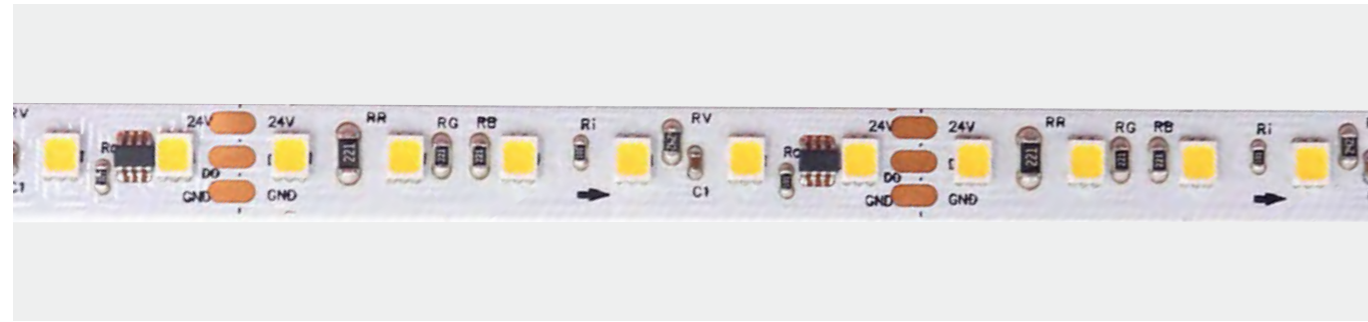

24V DC 8 Pixel 3 Line 10mm 2835 120LED White Color 8pixels Digital Strip

Model Number	Voltage (dc v)	Power (w)	LED Qty (pcs)	Lumens (lm/m)	Efficacy (lm/W)	CCT&Color (K)	CRI	Cutting unit (mm)	Bean Angle (o)
S10WXX-283527-024AD-120S-MY3-3X08	24	10	120	1440	80	2700	80/90	125	120
S10WXX-283530-024AD-120S-MY3-3X08	24	10	120	1530	85	3000	80/90	125	120
S10WXX-283540-024AD-120S-MY3-3X08	24	10	120	1620	90	4000	80/90	125	120
S10WXX-283560-024AD-120S-MY3-3X08	24	10	120	1530	85	6000	80/90	125	120

*The strip light will come with 5 meters /reel
*All the data above is just for reference under IP20. it is different with IP65, IP66, IP67, IP68

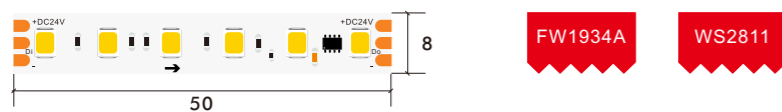

24V DC 20 Pixel 3 Line 8mm 2835 120LED White Color 20pixels Digital Strip

Model Number	Voltage (dc v)	Power (w)	LED Qty (pcs)	Lumens (lm/m)	Efficacy (lm/W)	CCT&Color (K)	CRI	Cutting unit (mm)	Bean Angle (o)
S08WXX-283527-024AD-120S-MY3-3X20	24	12	120	1152	80	2700	80/90	50	120
S08WXX-283530-024AD-120S-MY3-3X20	24	12	120	1224	85	3000	80/90	50	120
S08WXX-283540-024AD-120S-MY3-3X20	24	12	120	1296	90	4000	80/90	50	120
S08WXX-283560-024AD-120S-MY3-3X20	24	12	120	1224	85	6000	80/90	50	120

*The strip light will come with 5 meters /reel
*All the data above is just for reference under IP20. it is different with IP65, IP66, IP67, IP68



24V DC 20 Pixel 4 Line 8mm 2835 120LED White Color 20pixels Digital Strip

Model Number	Voltage (dc v)	Power (w)	LED Qty (pcs)	Lumens (lm/m)	Efficacy (lm/W)	CCT&Color (K)	CRI	Cutting unit (mm)	Bean Angle (o)
S08WXX-505027-024AD-120S-MY3-4X20	24	10	120	1152	80	2700	80/90	50	120
S08WXX-505030-024AD-120S-MY3-4X20	24	10	120	1224	85	3000	80/90	50	120
S08WXX-505040-024AD-120S-MY3-4X20	24	10	120	1296	90	4000	80/90	50	120
S08WXX-505060-024AD-120S-MY3-4X20	24	10	120	1224	85	6000	80/90	50	120

*The strip light will come with 5 meters /reel
*All the data above is just for reference under IP20. it is different with IP65, IP66, IP67, IP68

2835 WHITE COLOR 8MM 144LED DIGITAL STRIP

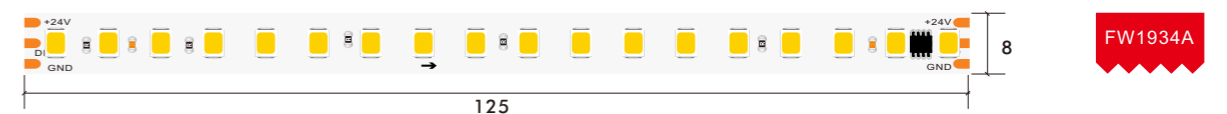

24V DC 8 Pixel 4 Line 8mm 2835 144LED White Color 8pixels Digital Strip

Model Number	Voltage (dc v)	Power (w)	LED Qty (pcs)	Lumens (lm/m)	Efficacy (lm/W)	CCT&Color (K)	CRI	Cutting unit (mm)	Bean Angle (o)
S08WXX-505027-024AD-144S-MY3-4X08	24	8.2	144	1920	80	2700	80/90	125	120
S08WXX-505030-024AD-144S-MY3-4X08	24	8.2	144	2040	85	3000	80/90	125	120
S08WXX-505040-024AD-144S-MY3-4X08	24	8.2	144	2160	90	4000	80/90	125	120
S08WXX-505060-024AD-144S-MY3-4X08	24	8.2	144	2040	85	6000	80/90	125	120

*The strip light will come with 5 meters /reel
*All the data above is just for reference under IP20. it is different with IP65, IP66, IP67, IP68

2835 WHITE COLOR 20MM 360LED DIGITAL STRIP

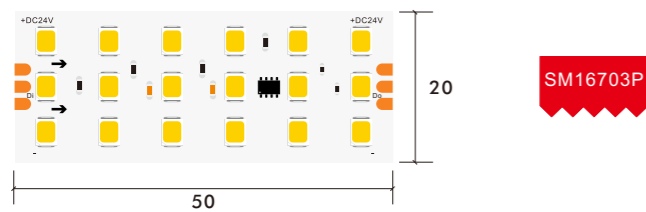
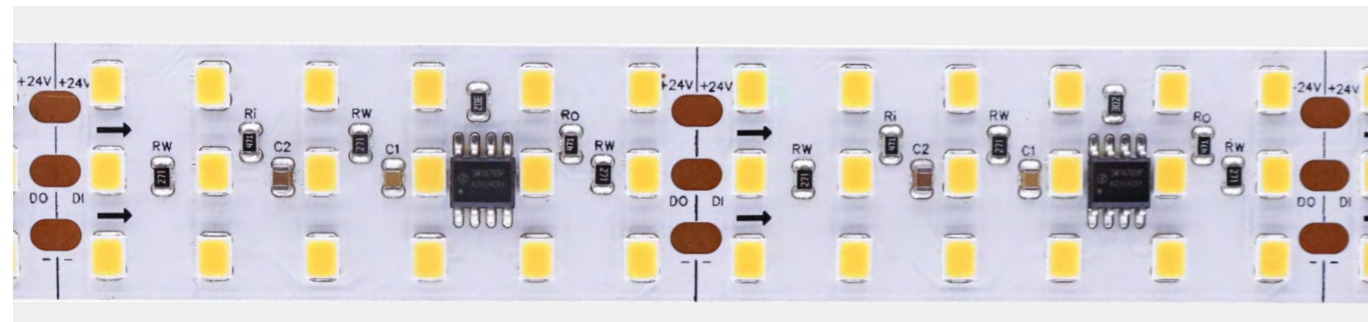

24V DC	20 Pixel	3 Line	20mm 2835 360LED White Color 20pixels Digital Strip	Model Number	Voltage (dc v)	Power (w)	LED Qty (pcs)	Lumens (lm/m)	Efficacy (lm/W)	CCT&Color (K)	CRI	Cutting unit (mm)	Bean Angle (o)
				S20WXX-283527-024AD-360T-MY3-3X20	24	25	360	2000	80	2700	80/90	50	120
				S20WXX-283530-024AD-360T-MY3-3X20	24	25	360	2125	85	3000	80/90	50	120
				S20WXX-283540-024AD-360T-MY3-3X20	24	25	360	2250	90	4000	80/90	50	120
				S20WXX-283560-024AD-360T-MY3-3X20	24	25	360	2125	85	6000	80/90	50	120

*The strip light will come with 5 meters /reel
*All the data above is just for reference under IP20. it is different with IP65, IP66, IP67, IP68

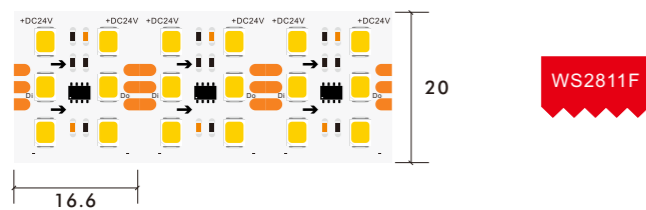

24V DC	60 Pixel	3 Line	20mm 2835 120LED White Color 60pixels Digital Strip	Model Number	Voltage (dc v)	Power (w)	LED Qty (pcs)	Lumens (lm/m)	Efficacy (lm/W)	CCT&Color (K)	CRI	Cutting unit (mm)	Bean Angle (o)
				S20WXX-283527-024AD-360T-MY3-3X60	24	22	360	1760	80	2700	80/90	16.6	120
				S20WXX-283530-024AD-360T-MY3-3X60	24	22	360	1870	85	3000	80/90	16.6	120
				S20WXX-283540-024AD-360T-MY3-3X60	24	22	360	1980	90	4000	80/90	16.6	120
				S20WXX-283560-024AD-360T-MY3-3X60	24	22	360	1870	85	6000	80/90	16.6	120

*The strip light will come with 5 meters /reel
*All the data above is just for reference under IP20. it is different with IP65, IP66, IP67, IP68

3527 CCT COLOR 8MM 120LED DIGITAL STRIP

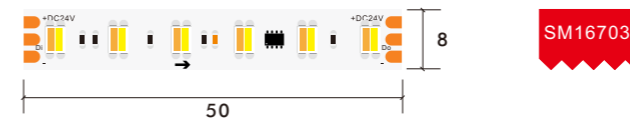
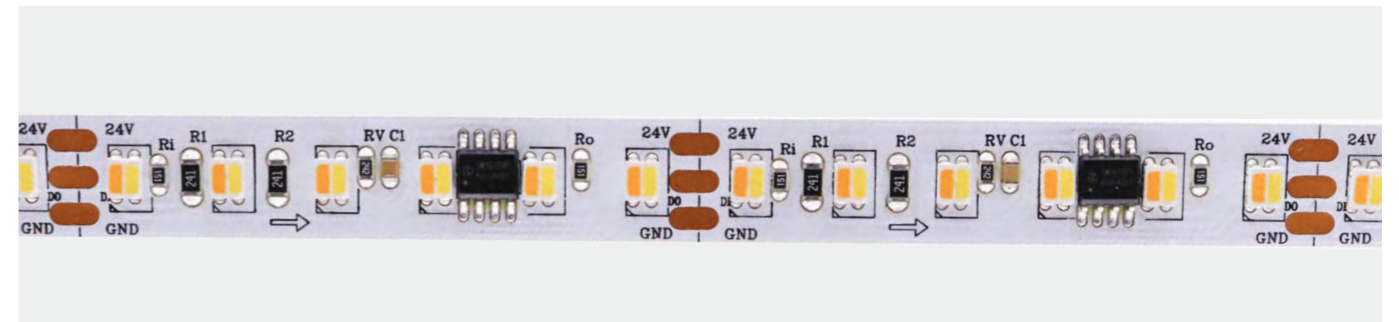

24V DC	20 Pixel	3 Line	8mm 3527 120LED Cct Color 20pixels Digital Strip	Model Number	Voltage (dc v)	Power (w)	LED Qty (pcs)	Lumens (lm/m)	Efficacy (lm/W)	CCT&Color (K)	CRI	Cutting unit (mm)	Bean Angle (o)
				S08WXX-3527TW-024AD-120S-MY3-3X30	24	18.7	120	1490	80	CCT	80/90	50	120

*The strip light will come with 5 meters /reel
*All the data above is just for reference under IP20. it is different with IP65, IP66, IP67, IP68

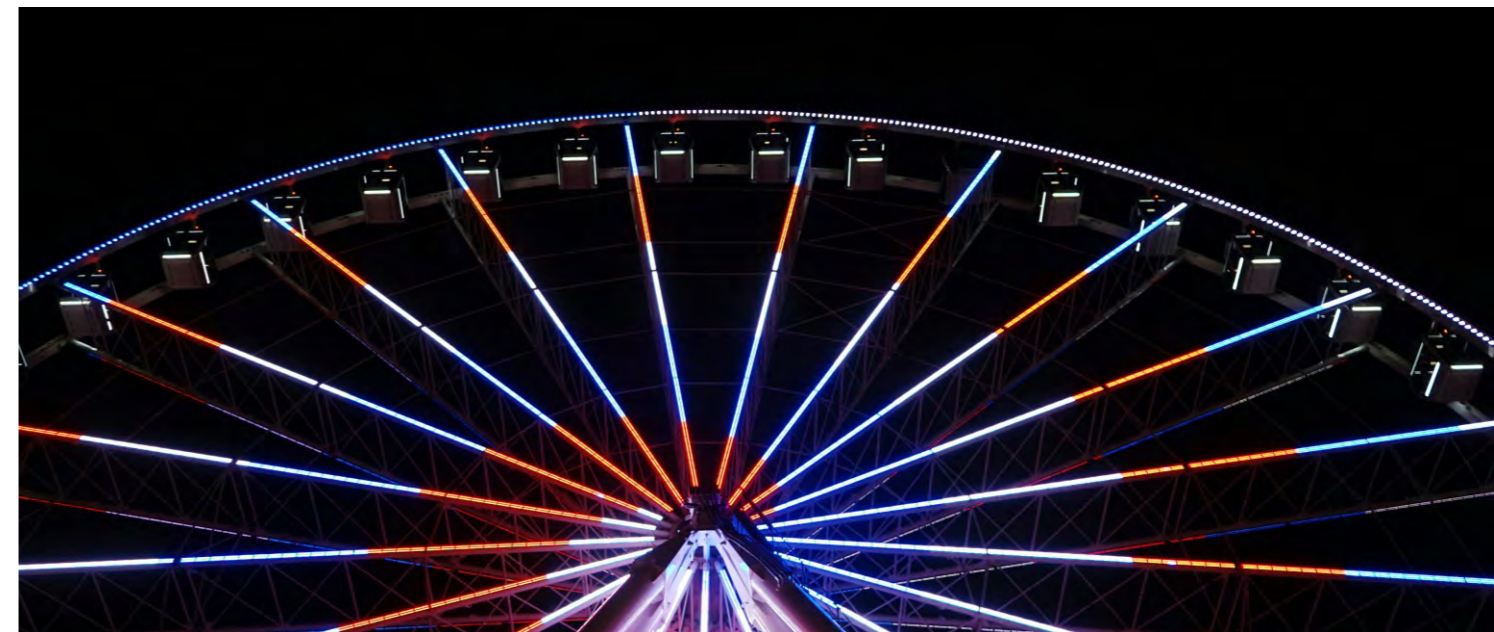

5050 TRIPLE WHITE 10MM 60LED DIGITAL STRIP

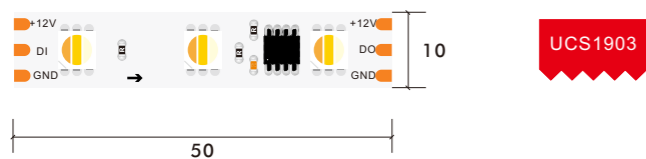
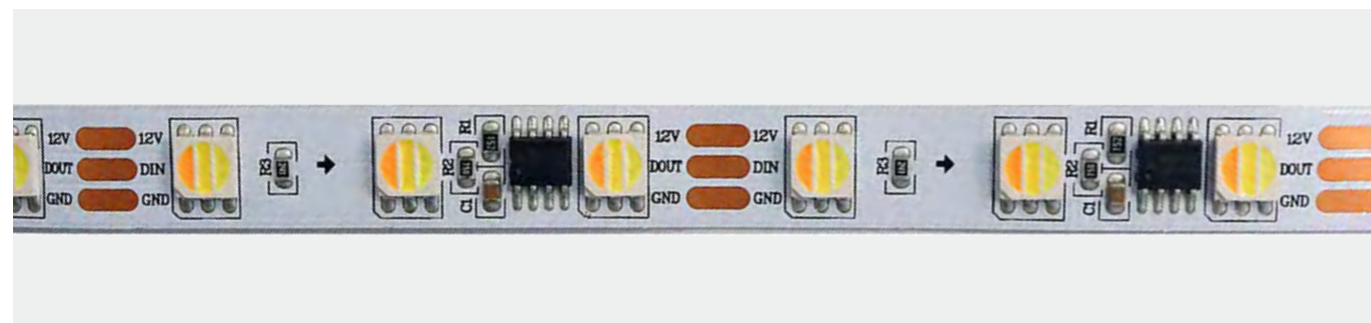

10mm 5050 60LED Triple White Color 20pixels Digital Strip

Model Number	Voltage (dc v)	Power (w)	LED Qty (pcs)	Lumens (lm/m)	Efficacy (lm/W)	CCT&Color (K)	CRI	Cutting unit (mm)	Bean Angle (o)
S10WXX-50503W-012AD-060S-MY3-3X20	12	12	60	1152	80	Triple White	80/90	50	120

*The strip light will come with 5 meters /reel
*All the data above is just for reference under IP20. it is different with IP65, IP66, IP67, IP68

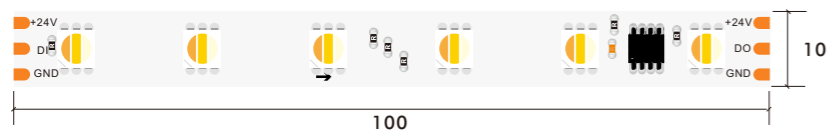

10mm 5050 60LED Triple White Color 10pixels Digital Strip

Model Number	Voltage (dc v)	Power (w)	LED Qty (pcs)	Lumens (lm/m)	Efficacy (lm/W)	CCT&Color (K)	CRI	Cutting unit (mm)	Bean Angle (o)
S10WXX-50503W-024AD-060S-MY3-3X10	24	12	60	1152	80	Triple White	80/90	100	120

*The strip light will come with 5 meters /reel
*All the data above is just for reference under IP20. it is different with IP65, IP66, IP67, IP68

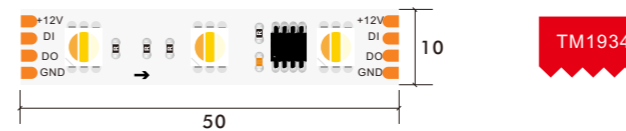

10mm 5050 60LED Triple White 20pixels Digital Strip

Model Number	Voltage (dc v)	Power (w)	LED Qty (pcs)	Lumens (lm/m)	Efficacy (lm/W)	CCT&Color (K)	CRI	Cutting unit (mm)	Bean Angle (o)
S10WXX-50503W-012AD-060S-MY3-4X20	12	12	60	960	80	Triple White	80/90	50	120

*The strip light will come with 5 meters /reel
*All the data above is just for reference under IP20. it is different with IP65, IP66, IP67, IP68

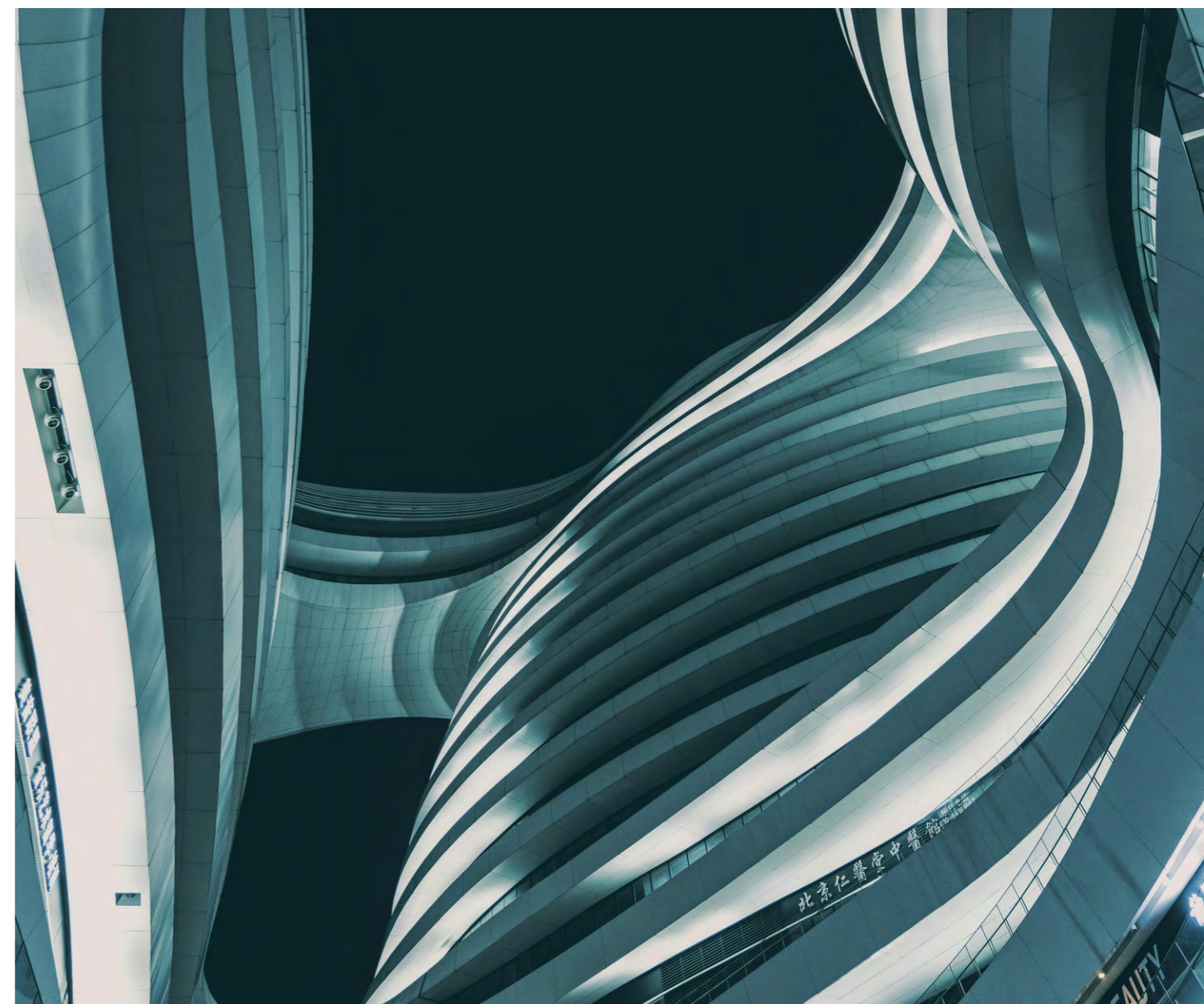

5050 RGB 10MM 60LED DIGITAL STRIP

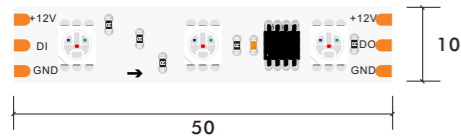
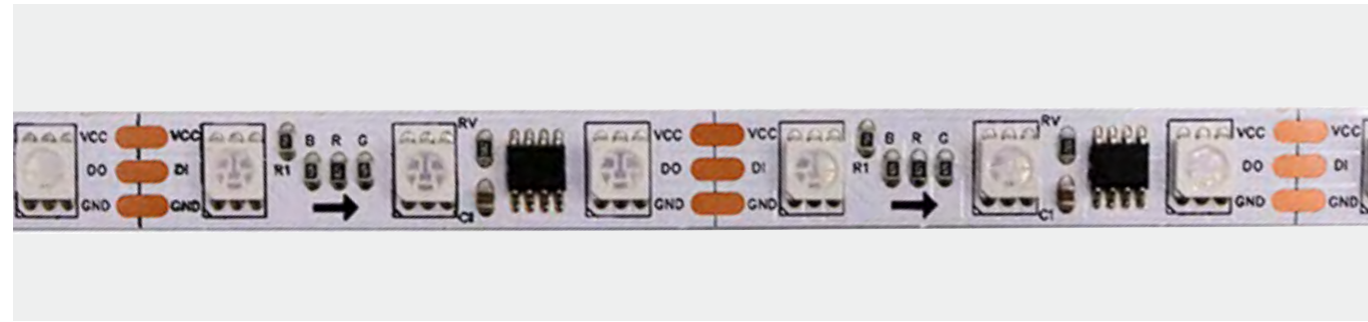

WS2811

UCS1903



12V DC	20 Pixel	3 Line	10mm 5050 60LED RGB Color 20pixels Digital Strip	Model Number	Voltage (dc v)	Power (w)	LED Qty (pcs)	Lumens (lm/m)	Efficacy (lm/W)	CCT&Color (K)	CRI	Cutting unit (mm)	Bean Angle (o)
				S10WXX-5050TC-012AD-060S-MY3-3X20	12	14.4	60	N/A	N/A	RGB	80/90	50	120

*The strip light will come with 5 meters /reel
*All the data above is just for reference under IP20. it is different with IP65, IP66, IP67, IP68

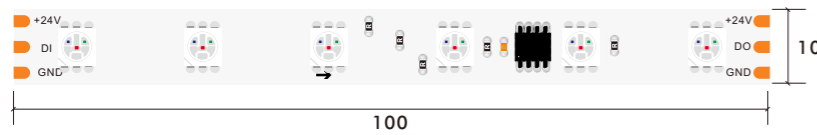

WS2811

UCS1903



24V DC	10 Pixel	3 Line	10mm 5050 60LED RGB Color 10pixels Digital Strip	Model Number	Voltage (dc v)	Power (w)	LED Qty (pcs)	Lumens (lm/m)	Efficacy (lm/W)	CCT&Color (K)	CRI	Cutting unit (mm)	Bean Angle (o)
				S10WXX-5050TC-024AD-060S-MY3-3X10	24	14.4	60	N/A	N/A	RGB	80/90	100	120

*The strip light will come with 5 meters /reel
*All the data above is just for reference under IP20. it is different with IP65, IP66, IP67, IP68

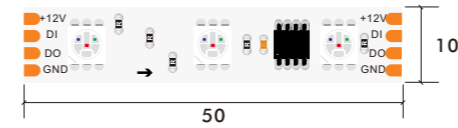

TM1934



12V DC	20 Pixel	4 Line	10mm 5050 60LED RGB Color 20pixels Digital Strip	Model Number	Voltage (dc v)	Power (w)	LED Qty (pcs)	Lumens (lm/m)	Efficacy (lm/W)	CCT&Color (K)	CRI	Cutting unit (mm)	Bean Angle (o)
				S10WXX-5050TC-012AD-060S-MY3-4X20	12	12	60	N/A	N/A	RGB	80/90	50	120

*The strip light will come with 5 meters /reel
*All the data above is just for reference under IP20. it is different with IP65, IP66, IP67, IP68

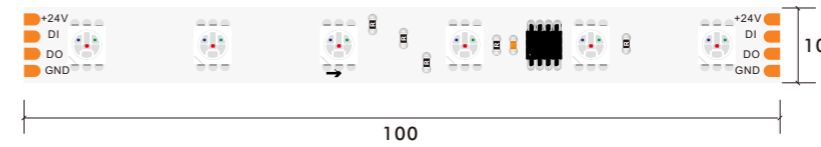

TM1934



24V DC	10 Pixel	4 Line	10mm 5050 60LED RGB Color 10pixels Digital Strip	Model Number	Voltage (dc v)	Power (w)	LED Qty (pcs)	Lumens (lm/m)	Efficacy (lm/W)	CCT&Color (K)	CRI	Cutting unit (mm)	Bean Angle (o)
				S10WXX-5050TC-024AD-060S-MY3-4X10	24	12	60	N/A	N/A	RGB	80/90	100	120

*The strip light will come with 5 meters /reel
*All the data above is just for reference under IP20. it is different with IP65, IP66, IP67, IP68

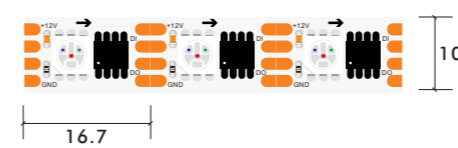

LB1908

GS8208



12V DC	60 Pixel	4 Line	10mm 5050 60LED RGB Color 60pixels Digital Strip	Model Number	Voltage (dc v)	Power (w)	LED Qty (pcs)	Lumens (lm/m)	Efficacy (lm/W)	CCT&Color (K)	CRI	Cutting unit (mm)	Bean Angle (o)
				S10WXX-5050TC-012AD-060S-MY3-4X60	12	14	60	N/A	N/A	RGB	80/90	100	120

*The strip light will come with 5 meters /reel
*All the data above is just for reference under IP20. it is different with IP65, IP66, IP67, IP68

2835 RGB COLOR 8/10 MM 120LED DIGITAL STRIP

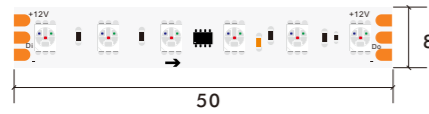
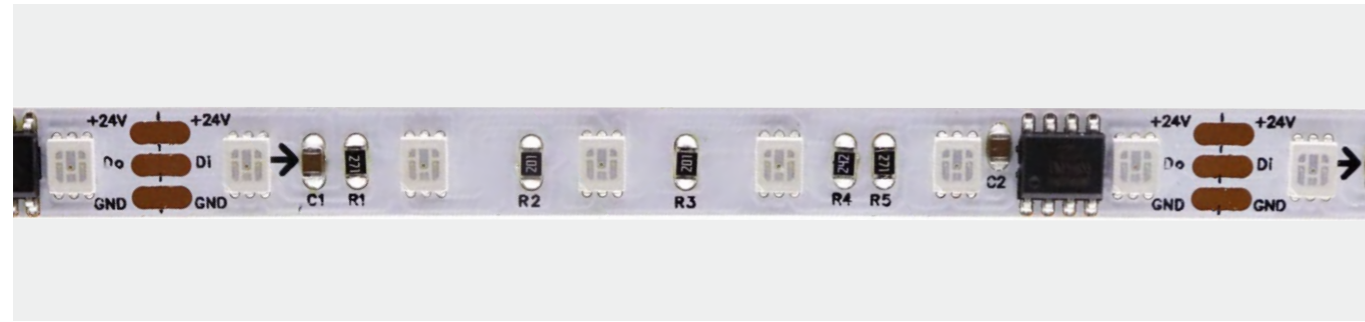

FW1903PE

WS2811



12V DC	20 Pixel	3 Line	8mm 2835 120LED RGB Color 20pixels Digital Strip	Model Number	Voltage (dc v)	Power (w)	LED Qty (pcs)	Lumens (lm/m)	Efficacy (lm/W)	CCT&Color (K)	CRI	Cutting unit (mm)	Beam Angle (o)
				S08WXX-2835TC-012AD-120S-MY3-3X20	12	10	120	N/A	N/A	RGB	80/90	50	120

*The strip light will come with 5 meters /reel
*All the data above is just for reference under IP20. it is different with IP65, IP66, IP67, IP68

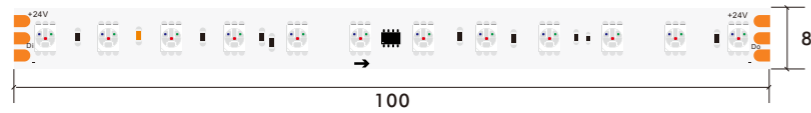

FW1903P



24V DC	10 Pixel	3 Line	8mm 2835 120LED RGB Color 10pixels Digital Strip	Model Number	Voltage (dc v)	Power (w)	LED Qty (pcs)	Lumens (lm/m)	Efficacy (lm/W)	CCT&Color (K)	CRI	Cutting unit (mm)	Beam Angle (o)
				S08WXX-2835TC-024AD-120S-MY3-3X10	24	11.5	120	N/A	N/A	RGB	80/90	100	120

*The strip light will come with 5 meters /reel
*All the data above is just for reference under IP20. it is different with IP65, IP66, IP67, IP68

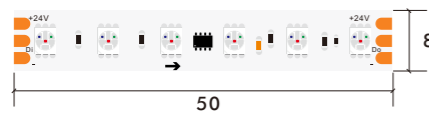

FW1903P



24V DC	20 Pixel	3 Line	8mm 2835 120LED RGB Color 20pixels Digital Strip	Model Number	Voltage (dc v)	Power (w)	LED Qty (pcs)	Lumens (lm/m)	Efficacy (lm/W)	CCT&Color (K)	CRI	Cutting unit (mm)	Beam Angle (o)
				S08WXX-2835TC-024AD-120S-MY3-3X20	24	15	120	N/A	N/A	RGB	80/90	100	120

*The strip light will come with 5 meters /reel
*All the data above is just for reference under IP20. it is different with IP65, IP66, IP67, IP68

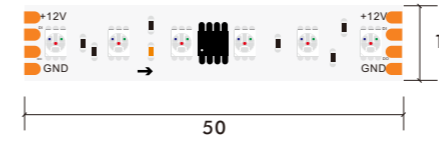

TM1934



12V DC	20 Pixel	4 Line	10mm 2835 120LED RGB Color 20pixels Digital Strip	Model Number	Voltage (dc v)	Power (w)	LED Qty (pcs)	Lumens (lm/m)	Efficacy (lm/W)	CCT&Color (K)	CRI	Cutting unit (mm)	Beam Angle (o)
				S10WXX-2835TC-012AD-120S-MY3-4X20	24	11	120	N/A	N/A	RGB	80/90	50	120

*The strip light will come with 5 meters /reel
*All the data above is just for reference under IP20. it is different with IP65, IP66, IP67, IP68

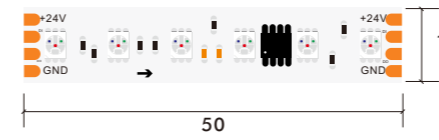

TM1934



24V DC	20 Pixel	4 Line	10mm 2835 120LED RGB Color 20pixels Digital Strip	Model Number	Voltage (dc v)	Power (w)	LED Qty (pcs)	Lumens (lm/m)	Efficacy (lm/W)	CCT&Color (K)	CRI	Cutting unit (mm)	Beam Angle (o)
				S10WXX-2835TC-024AD-120S-MY3-4X20	24	22	120	N/A	N/A	RGB	80/90	50	120

*The strip light will come with 5 meters /reel
*All the data above is just for reference under IP20. it is different with IP65, IP66, IP67, IP68

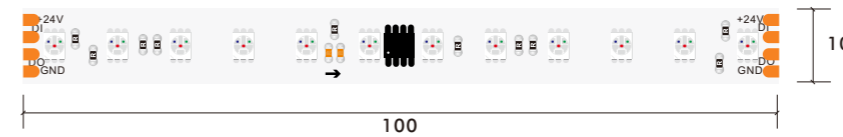

TM1934



24V DC	10 Pixel	4 Line	10mm 2835 120LED RGB Color 10pixels Digital Strip	Model Number	Voltage (dc v)	Power (w)	LED Qty (pcs)	Lumens (lm/m)	Efficacy (lm/W)	CCT&Color (K)	CRI	Cutting unit (mm)	Beam Angle (o)
				S10WXX-2835TC-024AD-120S-MY3-4X10	24	11	120	N/A	N/A	RGB	80/90	100	120

*The strip light will come with 5 meters /reel
*All the data above is just for reference under IP20. it is different with IP65, IP66, IP67, IP68



5050 RGB COLOR 20MM 120LED DIGITAL STRIP

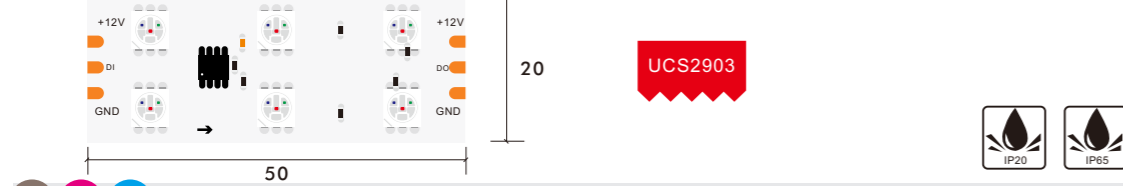
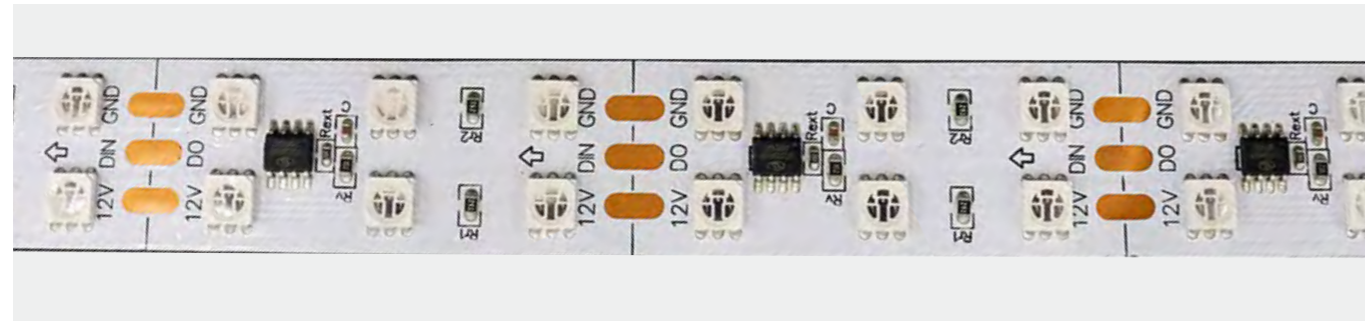

Model Number	Voltage (dc v)	Power (w)	LED Qty (pcs)	Lumens (lm/m)	Efficacy (lm/W)	CCT&Color (K)	CRI	Cutting unit (mm)	Beam Angle (o)
S20WXX-5050TC-012AD-120D-MY3-3X20	12	20	120	N/A	N/A	RGB	N/A	50	120

*The strip light will come with 5 meters /reel
*All the data above is just for reference under IP20. it is different with IP65, IP66, IP67, IP68



Model Number	Voltage (dc v)	Power (w)	LED Qty (pcs)	Lumens (lm/m)	Efficacy (lm/W)	CCT&Color (K)	CRI	Cutting unit (mm)	Beam Angle (o)
S20WXX-5050TC-012AD-120D-MY3-3X30	12	19	120	N/A	N/A	RGB	N/A	33.3	120

*The strip light will come with 5 meters /reel
*All the data above is just for reference under IP20. it is different with IP65, IP66, IP67, IP68

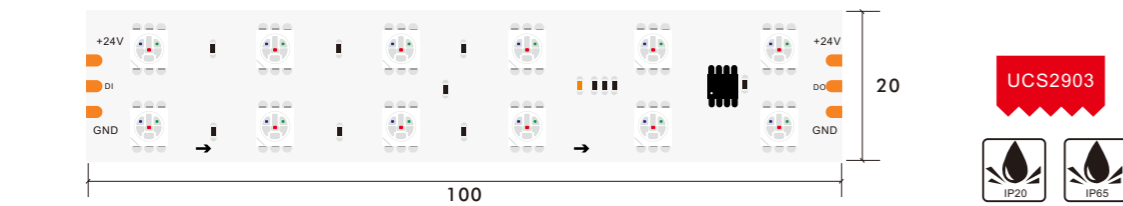

Model Number	Voltage (dc v)	Power (w)	LED Qty (pcs)	Lumens (lm/m)	Efficacy (lm/W)	CCT&Color (K)	CRI	Cutting unit (mm)	Beam Angle (o)
S20WXX-5050TC-024AD-120D-MY3-3x10	24	16	120	N/A	N/A	RGB	N/A	100	120

*The strip light will come with 5 meters /reel
*All the data above is just for reference under IP20. it is different with IP65, IP66, IP67, IP68

2835 RGB COLOR 20MM 240LED DIGITAL STRIP

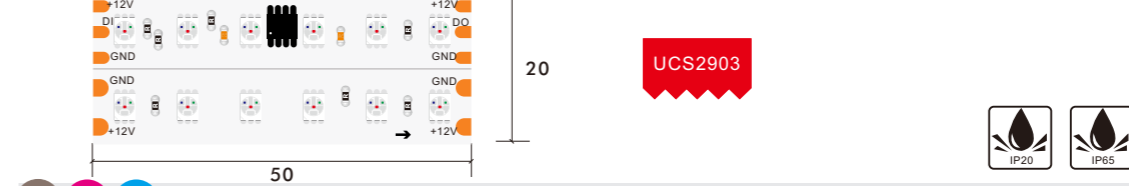
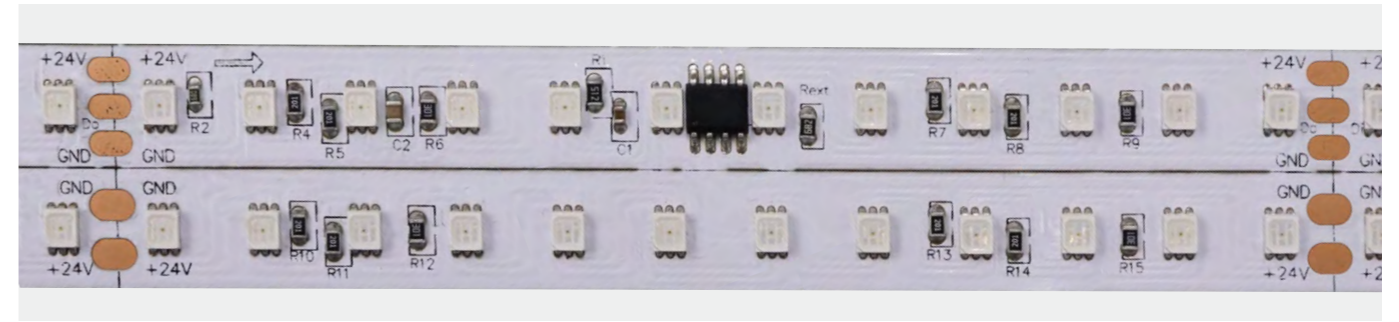

Model Number	Voltage (dc v)	Power (w)	LED Qty (pcs)	Lumens (lm/m)	Efficacy (lm/W)	CCT&Color (K)	CRI	Cutting unit (mm)	Beam Angle (o)
S20WXX-5050TC-024AD-240D-MY3-3X20	12	20	240	N/A	N/A	RGB	80/90	50	120

*The strip light will come with 5 meters /reel
*All the data above is just for reference under IP20. it is different with IP65, IP66, IP67, IP68

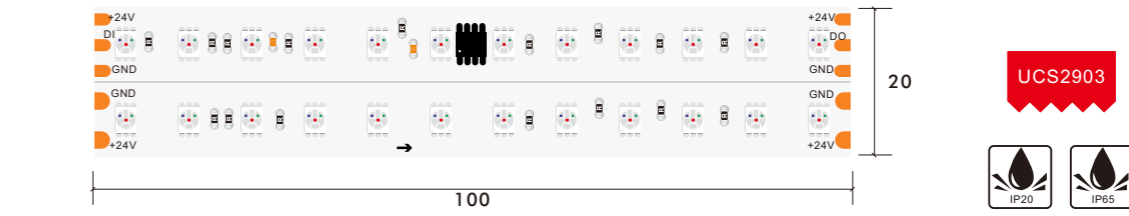

Model Number	Voltage (dc v)	Power (w)	LED Qty (pcs)	Lumens (lm/m)	Efficacy (lm/W)	CCT&Color (K)	CRI	Cutting unit (mm)	Beam Angle (o)
S20WXX-2835TC-024AD-240D-MY3-3X10	24	20	240	N/A	N/A	RGB	80/90	100	120

*The strip light will come with 5 meters /reel
*All the data above is just for reference under IP20. it is different with IP65, IP66, IP67, IP68

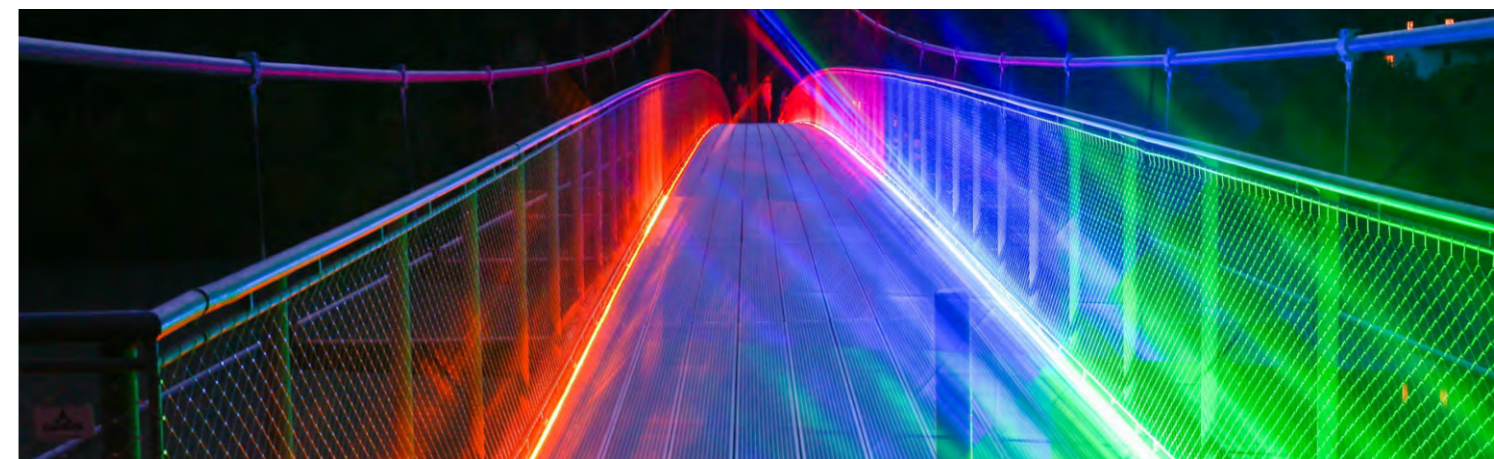

5050 RGBW COLOR 10MM 60LED DIGITAL STRIP

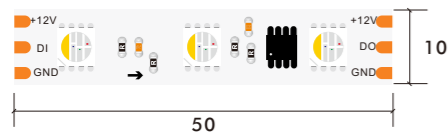
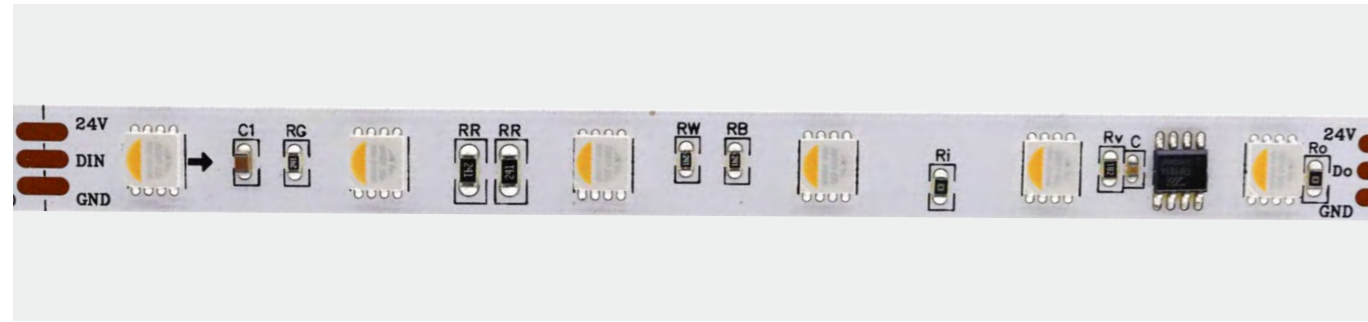

UCS2904B



12V DC	20 Pixel	3 Line	10mm 5050 60LED RGBW Color 20pixels Digital Strip	Model Number	Voltage (dc v)	Power (w)	LED Qty (pcs)	Lumens (lm/m)	Efficacy (lm/W)	CCT&Color (K)	CRI	Cutting unit (mm)	Bean Angle (o)
				S10WXX-5050MC-012AD-060S-MY3-3X20	12	18	60	N/A	N/A	RGBW	80/90	50	120

*The strip light will come with 5 meters /reel
*All the data above is just for reference under IP20. it is different with IP65, IP66, IP67, IP68

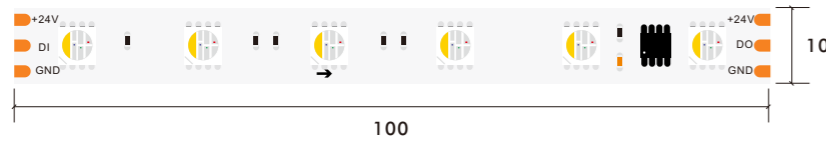

UCS2904B



24V DC	10 Pixel	3 Line	10mm 5050 60LED RGB Color 10pixels Digital Strip	Model Number	Voltage (dc v)	Power (w)	LED Qty (pcs)	Lumens (lm/m)	Efficacy (lm/W)	CCT&Color (K)	CRI	Cutting unit (mm)	Bean Angle (o)
				S10WXX-5050MC-024AD-060S-MY3-3X10	24	16	60	N/A	N/A	RGBW	80/90	100	120

*The strip light will come with 5 meters /reel
*All the data above is just for reference under IP20. it is different with IP65, IP66, IP67, IP68

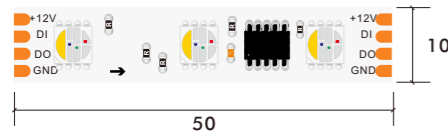

FW1834



12V DC	20 Pixel	4 Line	10mm 5050 60LED RGBW Color 20pixels Digital Strip	Model Number	Voltage (dc v)	Power (w)	LED Qty (pcs)	Lumens (lm/m)	Efficacy (lm/W)	CCT&Color (K)	CRI	Cutting unit (mm)	Bean Angle (o)
				S10WXX-5050MC-024AD-060S-MY3-4X20	12	10	60	N/A	N/A	RGBW	80/90	50	120

*The strip light will come with 5 meters /reel
*All the data above is just for reference under IP20. it is different with IP65, IP66, IP67, IP68

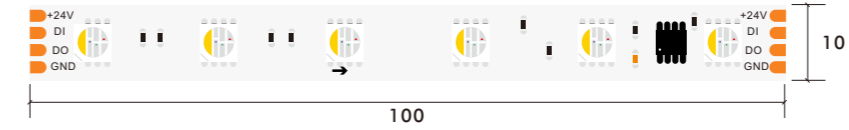

FW1834



24V DC	10 Pixel	4 Line	10mm 5050 60LED RGBW Color 10pixels Digital Strip	Model Number	Voltage (dc v)	Power (w)	LED Qty (pcs)	Lumens (lm/m)	Efficacy (lm/W)	CCT&Color (K)	CRI	Cutting unit (mm)	Bean Angle (o)
				S10WXX-5050MC-024AD-060S-MY3-4X10	24	10	60	N/A	N/A	RGBW	80/90	100	120

*The strip light will come with 5 meters /reel
*All the data above is just for reference under IP20. it is different with IP65, IP66, IP67, IP68

5050 RGBW COLOR 10MM 72LED DIGITAL STRIP

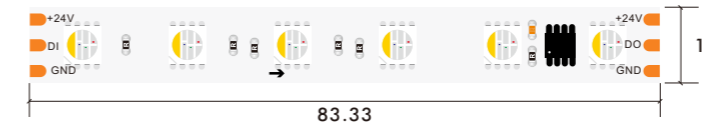

UCS2904B



24V DC	12 Pixel	3 Line	10mm 5050 60LED RGBW Color 12pixels Digital Strip	Model Number	Voltage (dc v)	Power (w)	LED Qty (pcs)	Lumens (lm/m)	Efficacy (lm/W)	CCT&Color (K)	CRI	Cutting unit (mm)	Bean Angle (o)
				S10WXX-5050MC-024AD-072S-MY3-3X12	24	22	72	N/A	N/A	RGBW	80/90	83.3	120

*The strip light will come with 5 meters /reel
*All the data above is just for reference under IP20. it is different with IP65, IP66, IP67, IP68

5050 RGBW COLOR 8/10/12 MM 84LED DIGITAL STRIP

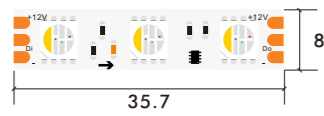
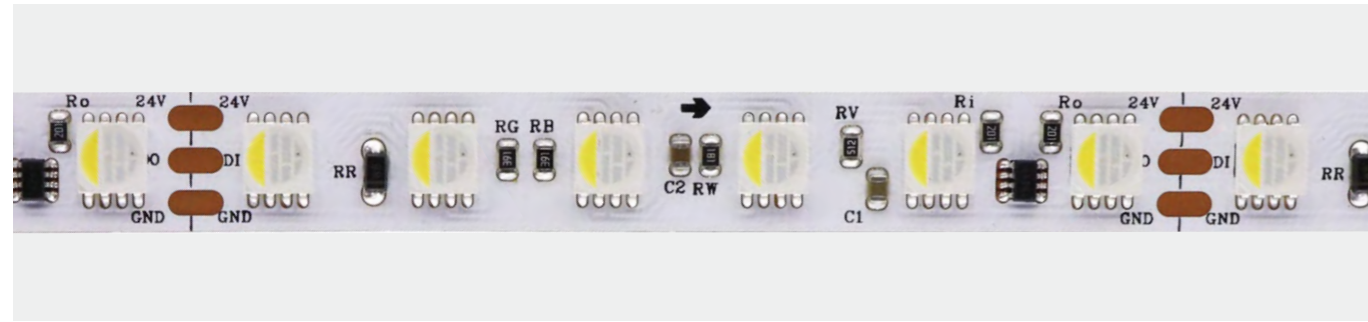

TM1824P



12V DC 28 Pixel 3 Line 8mm 5050 84LED RGBW Color 28pixels Digital Strip

Model Number	Voltage (dc v)	Power (w)	LED Qty (pcs)	Lumens (lm/m)	Efficacy (lm/W)	CCT&Color (K)	CRI	Cutting unit (mm)	Bean Angle (o)
S08WXX-5050MC-012AD-084S-MY3-3X28	12	13.8	84	N/A	N/A	RGBW	80/90	35.7	120

*The strip light will come with 5 meters /reel
*All the data above is just for reference under IP20. it is different with IP65, IP66, IP67, IP68

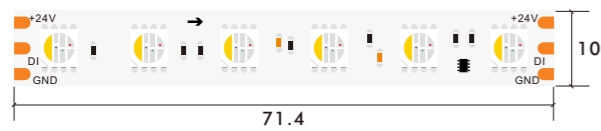

TM1824P



24V DC 14 Pixel 3 Line 10mm 5050 60LED RGBW Color 14pixels Digital Strip

Model Number	Voltage (dc v)	Power (w)	LED Qty (pcs)	Lumens (lm/m)	Efficacy (lm/W)	CCT&Color (K)	CRI	Cutting unit (mm)	Bean Angle (o)
S10WXX-5050MC-024AD-084S-MY3-3X14	24	14	84	N/A	N/A	RGBW	80/90	71.4	120

*The strip light will come with 5 meters /reel
*All the data above is just for reference under IP20. it is different with IP65, IP66, IP67, IP68

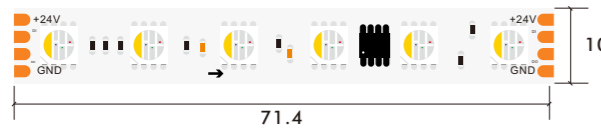

UCS2904B



24V DC 14 Pixel 4 Line 10mm 5050 84LED RGBW Color 14pixels Digital Strip

Model Number	Voltage (dc v)	Power (w)	LED Qty (pcs)	Lumens (lm/m)	Efficacy (lm/W)	CCT&Color (K)	CRI	Cutting unit (mm)	Bean Angle (o)
S10WXX-5050MC-024AD-084S-MY3-4X14	24	15	84	N/A	N/A	RGBW	80/90	71.4	120

*The strip light will come with 5 meters /reel
*All the data above is just for reference under IP20. it is different with IP65, IP66, IP67, IP68

4040 RGBW COLOR 8MM 120LED DIGITAL STRIP

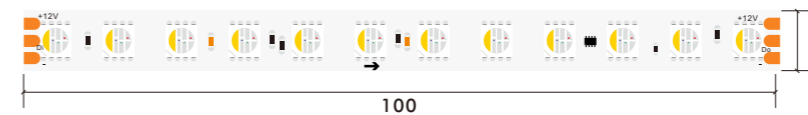
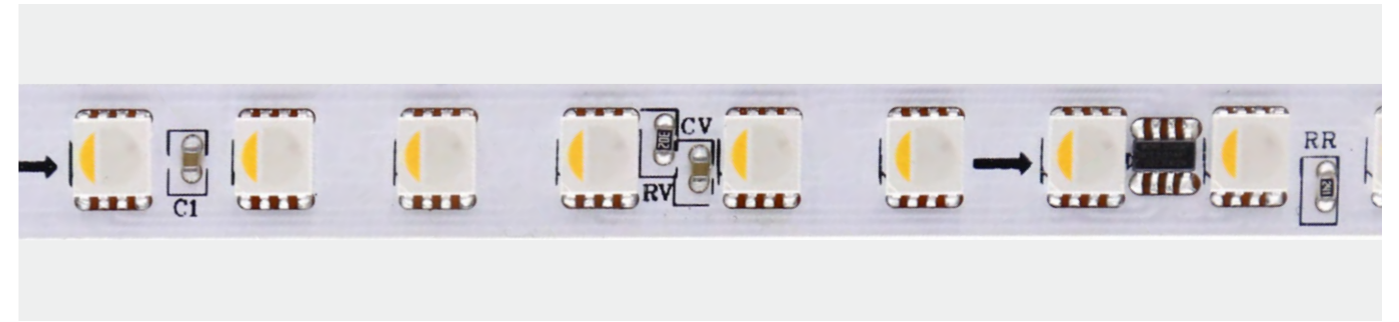

WS2814F



12V DC 10 Pixel 3 Line 8mm 4040 120LED RGBW Color 10pixels Digital Strip

Model Number	Voltage (dc v)	Power (w)	LED Qty (pcs)	Lumens (lm/m)	Efficacy (lm/W)	CCT&Color (K)	CRI	Cutting unit (mm)	Bean Angle (o)
S08WXX-4040MC-012AD-120S-MY3-3X10	12	7.5	120	N/A	N/A	RGBW	80/90	100	120

*The strip light will come with 5 meters /reel
*All the data above is just for reference under IP20. it is different with IP65, IP66, IP67, IP68

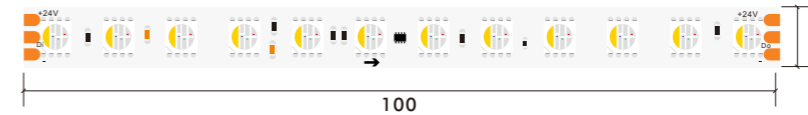

WS2814F



24V DC 10 Pixel 3 Line 8mm 4040 120LED RGBW Color 10pixels Digital Strip

Model Number	Voltage (dc v)	Power (w)	LED Qty (pcs)	Lumens (lm/m)	Efficacy (lm/W)	CCT&Color (K)	CRI	Cutting unit (mm)	Bean Angle (o)
S08WXX-4040MC-024AD-120S-MY3-3X10	24	15	120	N/A	N/A	RGBW	80/90	100	120

*The strip light will come with 5 meters /reel
*All the data above is just for reference under IP20. it is different with IP65, IP66, IP67, IP68



5050 RGBCCT 10MM 60LED DIGITAL

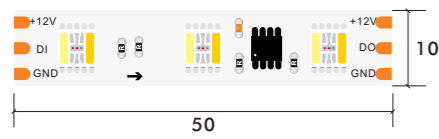
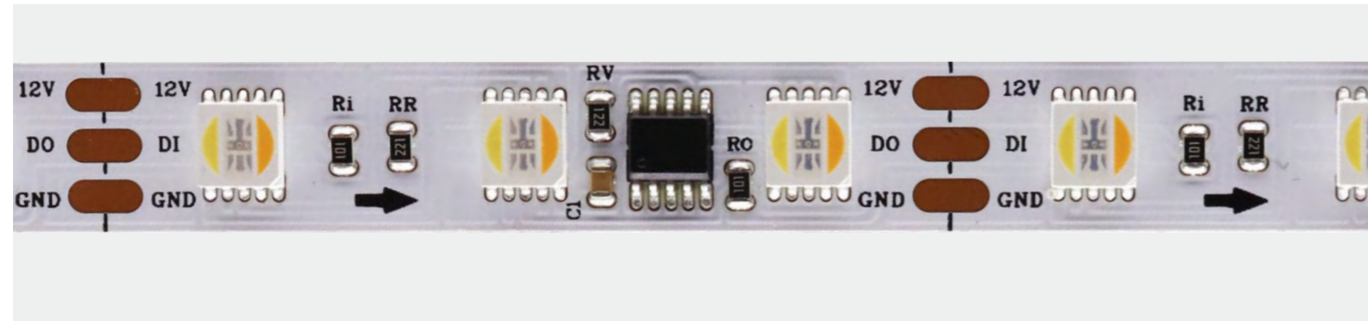

FW1906



12V DC 20 Pixel 3 Line

10mm 5050 60LED RGBWW Color 20pixels Digital Strip

Model Number	Voltage (dc v)	Power (w)	LED Qty (pcs)	Lumens (lm/m)	Efficacy (lm/W)	CCT&Color (K)	CRI	Cutting unit (mm)	Bean Angle (o)
S10WXX-5050FC-012AD-060S-MY3-3X20	12	22	60	N/A	N/A	RGBCCT	80/90	50	120

*The strip light will come with 5 meters /reel
*All the data above is just for reference under IP20. it is different with IP65, IP66, IP67, IP68

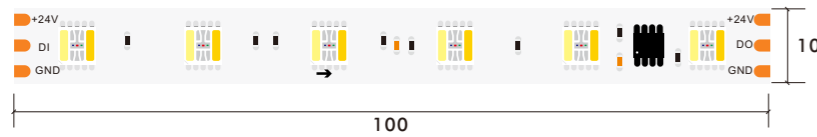

FW1906



24V DC 10 Pixel 3 Line

10mm 5050 60LED RGBWW Color 10pixels Digital Strip

Model Number	Voltage (dc v)	Power (w)	LED Qty (pcs)	Lumens (lm/m)	Efficacy (lm/W)	CCT&Color (K)	CRI	Cutting unit (mm)	Bean Angle (o)
S10WXX-5050FC-024AD-060S-MY3-3X10	24	22	60	N/A	N/A	RGBCCT	80/90	100	120

*The strip light will come with 5 meters /reel
*All the data above is just for reference under IP20. it is different with IP65, IP66, IP67, IP68

5050 RGBCCT 12MM 84LED DIGITAL STRIP

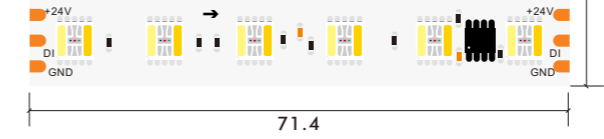

FW1906



12V DC 14 Pixel 3 Line

12mm 5050 84LED RGBWW Color 14pixels Digital Strip

Model Number	Voltage (dc v)	Power (w)	LED Qty (pcs)	Lumens (lm/m)	Efficacy (lm/W)	CCT&Color (K)	CRI	Cutting unit (mm)	Bean Angle (o)
S12WXX-5050FC-024CV-084S-MY3-3X14	24	32	84	N/A	N/A	RGBCCT	80/90	71.4	120

*The strip light will come with 5 meters /reel
*All the data above is just for reference under IP20. it is different with IP65, IP66, IP67, IP68

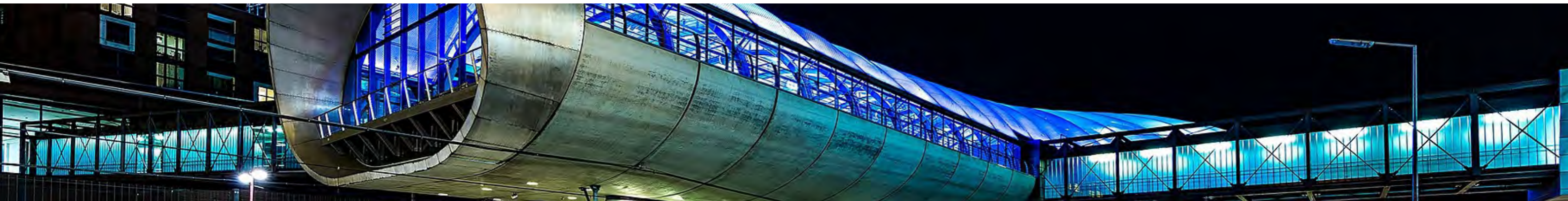

INTERNAL SPI LED STRIP



5050 RGB COLOR 10MM 60LED DIGITAL STRIP

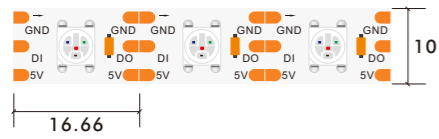
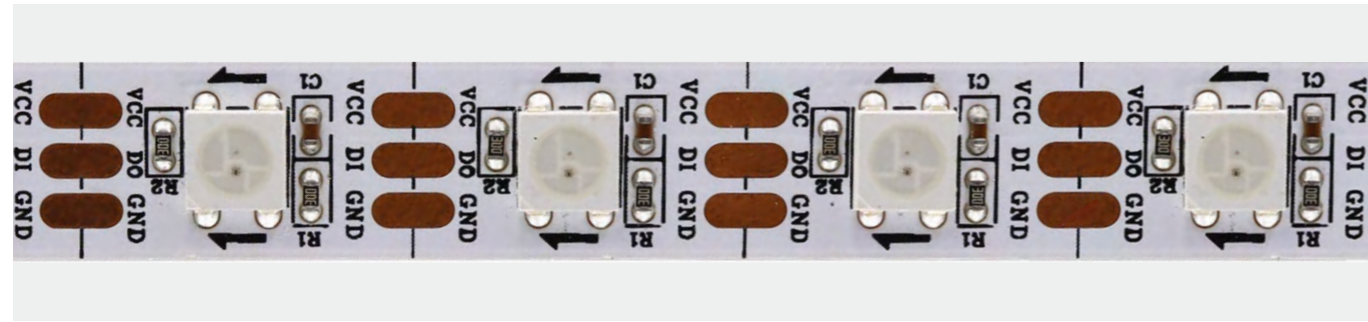

SK6812

WS2812



5V DC 60 Pixel 3 Line 10mm 5050 60LED RGB Color 60pixels Digital Strip

Model Number	Voltage (dc v)	Power (w)	LED Qty (pcs)	Lumens (lm/m)	Efficacy (lm/W)	CCT&Color (K)	CRI	Cutting unit (mm)	Beam Angle (o)
S10WXX-5050TC-005AD-060S-MY3-3X60	5	14	60	N/A	N/A	RGB	80/90	16.6	120

*The strip light will come with 5 meters /reel
*All the data above is just for reference under IP20. it is different with IP65, IP66, IP67, IP68



Ws2813

APA102

SK9822



5V DC 60 Pixel 4 Line 10mm 5050 60LED RGB Color 60pixels Digital Strip

Model Number	Voltage (dc v)	Power (w)	LED Qty (pcs)	Lumens (lm/m)	Efficacy (lm/W)	CCT&Color (K)	CRI	Cutting unit (mm)	Beam Angle (o)
S10WXX-5050TC-005AD-060S-MY3-4X60	5	7	60	N/A	N/A	RGB	80/90	16.6	120

*The strip light will come with 5 meters /reel
*All the data above is just for reference under IP20. it is different with IP65, IP66, IP67, IP68

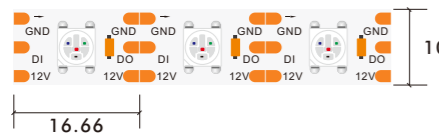

SK6812



12V DC 60 Pixel 3 Line 10mm 5050 60LED RGB Color 60pixels Digital Strip

Model Number	Voltage (dc v)	Power (w)	LED Qty (pcs)	Lumens (lm/m)	Efficacy (lm/W)	CCT&Color (K)	CRI	Cutting unit (mm)	Beam Angle (o)
S10WXX-5050TC-012AD-060S-MY3-3X60	12	14	60	N/A	N/A	RGB	80/90	16.6	120

*The strip light will come with 5 meters /reel
*All the data above is just for reference under IP20. it is different with IP65, IP66, IP67, IP68

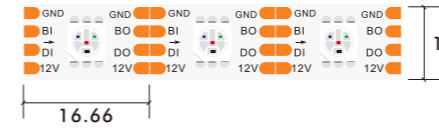

WS2815E

SK6813

GS8208



12V DC 60 Pixel 4 Line 10mm 5050 60LED RGB Color 60pixels Digital Strip

Model Number	Voltage (dc v)	Power (w)	LED Qty (pcs)	Lumens (lm/m)	Efficacy (lm/W)	CCT&Color (K)	CRI	Cutting unit (mm)	Beam Angle (o)
S10WXX-5050TC-012CV-060S-MY3-4X60	12	14	60	N/A	N/A	RGB	80/90	16.66	120

*The strip light will come with 5 meters /reel
*All the data above is just for reference under IP20. it is different with IP65, IP66, IP67, IP68



5050 RGB COLOR 12MM 144LED DIGITAL STRIP

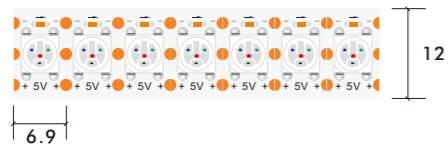
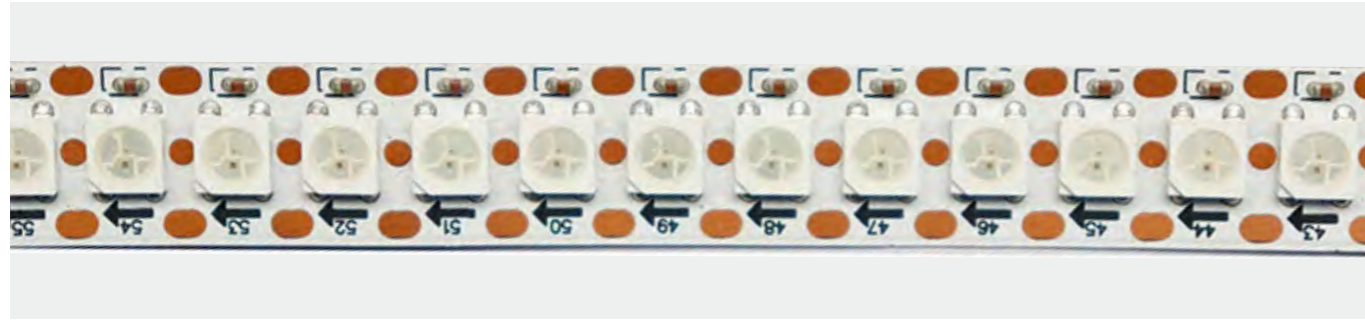

SK6812



Model Number	Voltage (dc v)	Power (w)	LED Qty (pcs)	Lumens (lm/m)	Efficacy (lm/W)	CCT&Color (K)	CRI	Cutting unit (mm)	Beam Angle (o)
S12WXX-5050TC-005AD-144S-MY3-3X144	5	24	144	N/A	N/A	RGB	80/90	6.9	120

*The strip light will come with 5 meters /reel
*All the data above is just for reference under IP20. it is different with IP65, IP66, IP67, IP68

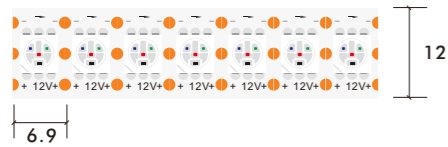

SK6812



Model Number	Voltage (dc v)	Power (w)	LED Qty (pcs)	Lumens (lm/m)	Efficacy (lm/W)	CCT&Color (K)	CRI	Cutting unit (mm)	Beam Angle (o)
S12WXX-2835TC-024AD-060S-MY3-3X144	24	25	144	N/A	N/A	RGB	80/90	6.9	120

*The strip light will come with 5 meters /reel
*All the data above is just for reference under IP20. it is different with IP65, IP66, IP67, IP68

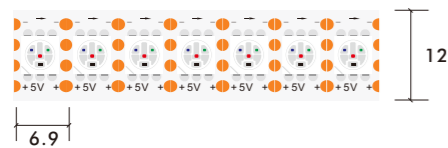

WS2813



Model Number	Voltage (dc v)	Power (w)	LED Qty (pcs)	Lumens (lm/m)	Efficacy (lm/W)	CCT&Color (K)	CRI	Cutting unit (mm)	Beam Angle (o)
S12WXX-5050TC-012AD-144S-MY3-4X144	12	25	144	N/A	N/A	RGB	80/90	6.9	120

*The strip light will come with 5 meters /reel
*All the data above is just for reference under IP20. it is different with IP65, IP66, IP67, IP68

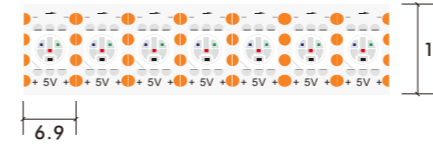

SK6813

SK6809



Model Number	Voltage (dc v)	Power (w)	LED Qty (pcs)	Lumens (lm/m)	Efficacy (lm/W)	CCT&Color (K)	CRI	Cutting unit (mm)	Beam Angle (o)
S12WXX-5050TC-012AD-144S-MY3-4X144	12	25	144	N/A	N/A	RGB	80/90	6.9	120

*The strip light will come with 5 meters /reel
*All the data above is just for reference under IP20. it is different with IP65, IP66, IP67, IP68



3535 RGB COLOR 7MM 144LED DIGITAL STRIP

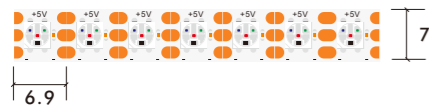

SK6812

5V DC 144 Pixel 3 Line

7mm 3535 144LED RGB Color 144pixels Digital Strip

Model Number	Voltage (dc v)	Power (w)	LED Qty (pcs)	Lumens (lm/m)	Efficacy (lm/W)	CCT&Color (K)	CRI	Cutting unit (mm)	Bean Angle (o)
S07WXX-3535TC-005AD-144S-MY3-3X144	5	20	144	N/A	N/A	RGB	N/A	6.9	120

*The strip light will come with 5 meters /reel
*All the data above is just for reference under IP20. it is different with IP65, IP66, IP67, IP68



SK6812

SK6809



12V DC 144 Pixel 3 Line

7mm 3535 144LED RGB Color 144pixels Digital Strip

Model Number	Voltage (dc v)	Power (w)	LED Qty (pcs)	Lumens (lm/m)	Efficacy (lm/W)	CCT&Color (K)	CRI	Cutting unit (mm)	Bean Angle (o)
S07WXX-3535TC-012AD-144S-MY3-3X144	12	14	144	N/A	N/A	RGB	N/A	6.9	120

*The strip light will come with 5 meters /reel
*All the data above is just for reference under IP20. it is different with IP65, IP66, IP67, IP68

5050 RGBW COLOR DIGITAL STRIP

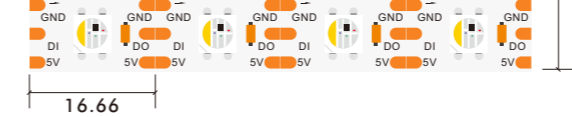
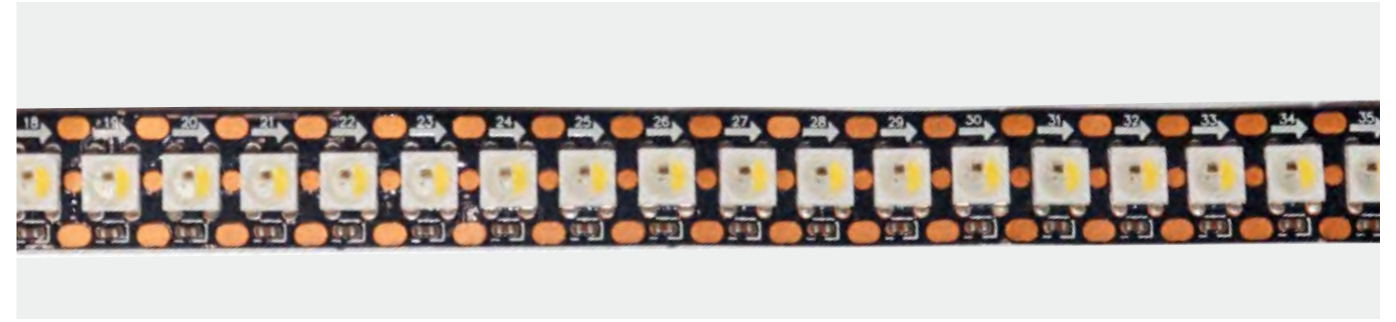

SK6812

5V DC 60 Pixel 3 Line

10mm 5050 60LED RGBW Color 60pixels Digital Strip

Model Number	Voltage (dc v)	Power (w)	LED Qty (pcs)	Lumens (lm/m)	Efficacy (lm/W)	CCT&Color (K)	CRI	Cutting unit (mm)	Bean Angle (o)
S10WXX-5050MC-005AD-060S-MY3-3X60	5	11.8	60	N/A	N/A	RGBW	80/90	16.6	120

*The strip light will come with 5 meters /reel
*All the data above is just for reference under IP20. it is different with IP65, IP66, IP67, IP68

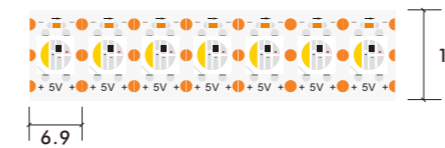

SK6812



5V DC 144 Pixel 3 Line

12mm 5050 144LED RGBW Color 144pixels Digital Strip

Model Number	Voltage (dc v)	Power (w)	LED Qty (pcs)	Lumens (lm/m)	Efficacy (lm/W)	CCT&Color (K)	CRI	Cutting unit (mm)	Bean Angle (o)
S12WXX-5050MC-005AD-144S-MY3-3X144	5	25	144	N/A	N/A	RGBW	80/90	6.9	120

*The strip light will come with 5 meters /reel
*All the data above is just for reference under IP20. it is different with IP65, IP66, IP67, IP68



DMX 512 LED STRIP LIGHT

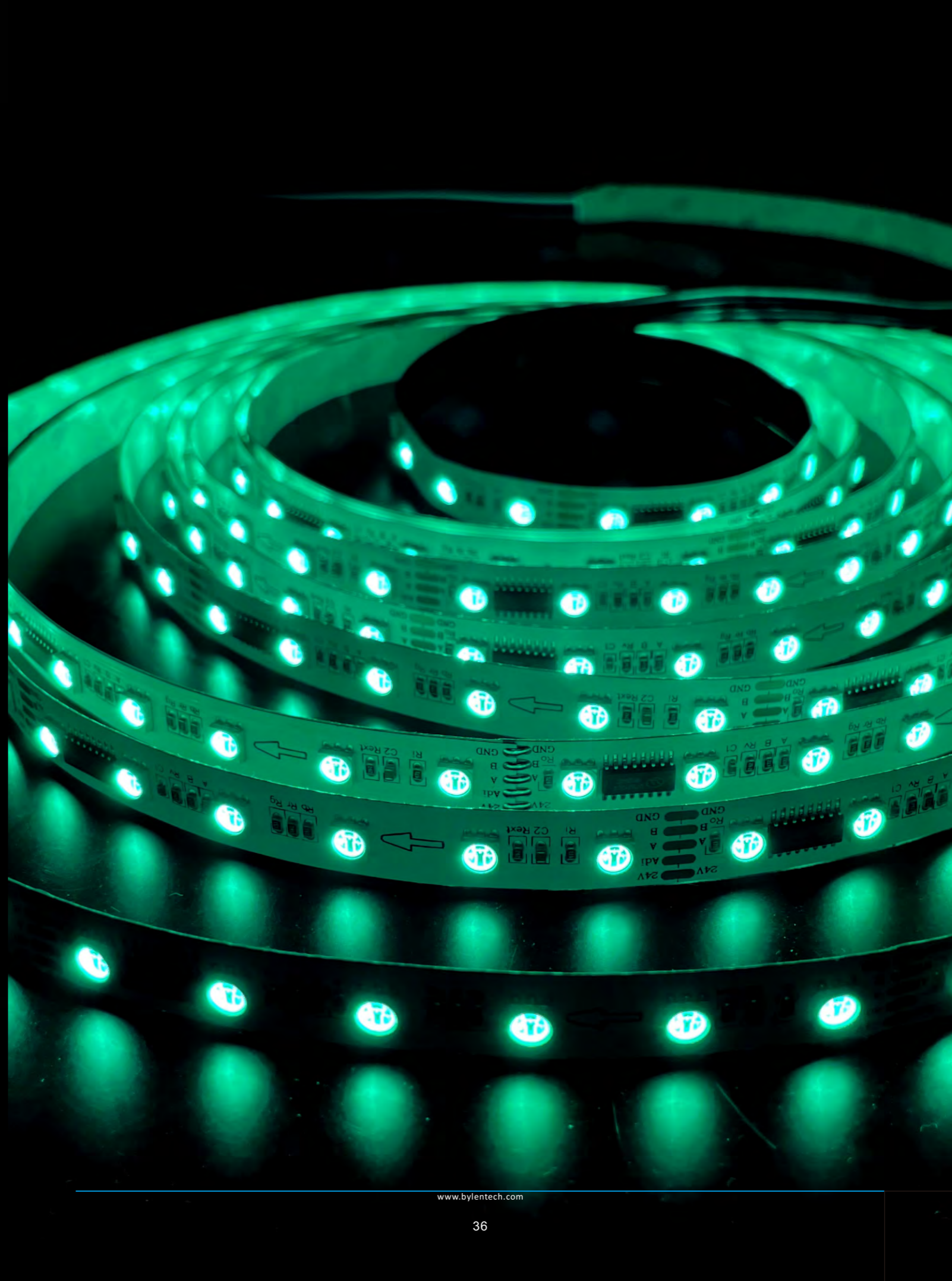

2835 120LED WHITE COLOR DMX STRIP



UCS512H5L

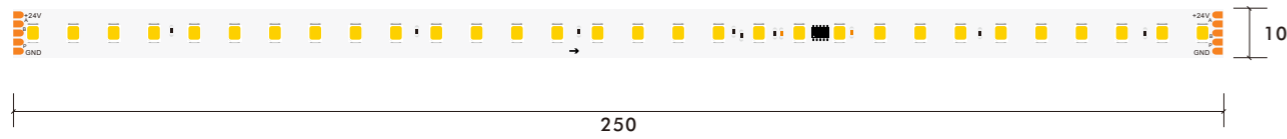

10mm 2835 120LED White Color 4pixels Dmx Strip

Model Number	Voltage (dc v)	Power (w)	LED Qty (pcs)	Lumens (lm/m)	Efficacy (lm/W)	CCT&Color (K)	CRI	Cutting unit (mm)	Bean Angle (o)
S10WXX-283527-024DMX-120S-MY3-5X04	24	6.5	120	552	85	2700	80/90	250	120
S10WXX-283530-024DMX-120S-MY3-5X04	24	6.5	120	585	90	3000	80/90	250	120
S10WXX-283540-024DMX-120S-MY3-5X04	24	6.5	120	615	95	4000	80/90	250	120
S10WXX-283560-024DMX-120S-MY3-5X04	24	6.5	120	585	90	6000	80/90	250	120

*The strip light will come with 5 meters /reel
*All the data above is just for reference under IP20. it is different with IP65, IP66, IP67, IP68



10mm 2835 120LED White Color 6pixels Dmx Strip

Model Number	Voltage (dc v)	Power (w)	LED Qty (pcs)	Lumens (lm/m)	Efficacy (lm/W)	CCT&Color (K)	CRI	Cutting unit (mm)	Bean Angle (o)
S10WXX-283527-024DMX-120S-MY3-5X06	24	11	120	935	85	2700	80/90	166	120
S10WXX-283530-024DMX-120S-MY3-5X06	24	11	120	990	90	3000	80/90	166	120
S10WXX-283540-024DMX-120S-MY3-5X06	24	11	120	1045	95	4000	80/90	166	120
S10WXX-283560-024DMX-120S-MY3-5X06	24	11	120	990	90	6000	80/90	166	120

*The strip light will come with 5 meters /reel
*All the data above is just for reference under IP20. it is different with IP65, IP66, IP67, IP68



UCS512H4L



10mm 2835 120LED White Color Dmx 8 Pixels Strip

Model Number	Voltage (dc v)	Power (w)	LED Qty (pcs)	Lumens (lm/m)	Efficacy (lm/W)	CCT&Color (K)	CRI	Cutting unit (mm)	Bean Angle (o)
S10WXX-283527-024DMX-120S-MY3-5X08	24	12	120	1020	85	2700	80/90	125	120
S10WXX-283530-024DMX-120S-MY3-5X08	24	12	120	1080	90	3000	80/90	125	120
S10WXX-283540-024DMX-120S-MY3-5X08	24	12	120	1140	95	4000	80/90	125	120
S10WXX-283560-024DMX-120S-MY3-5X08	24	12	120	1080	90	6000	80/90	125	120

*The strip light will come with 5 meters /reel
*All the data above is just for reference under IP20. it is different with IP65, IP66, IP67, IP68

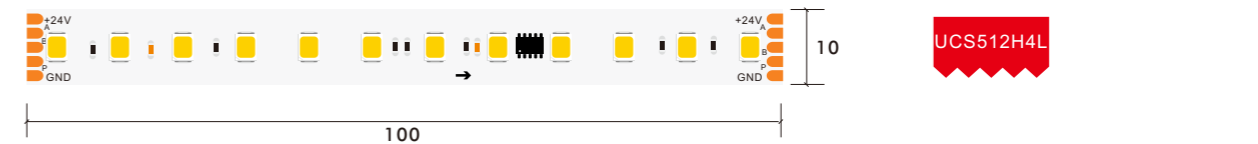

UCS512H4L



10mm 2835 120LED White Color 10pixels Dmx Strip

Model Number	Voltage (dc v)	Power (w)	LED Qty (pcs)	Lumens (lm/m)	Efficacy (lm/W)	CCT&Color (K)	CRI	Cutting unit (mm)	Bean Angle (o)
S10WXX-283527-024DMX-120S-MY3-5X10	24	19	120	1632	85	2700	80/90	100	120
S10WXX-283530-024DMX-120S-MY3-5X10	24	19	120	1728	90	3000	80/90	100	120
S10WXX-283540-024DMX-120S-MY3-5X10	24	19	120	1824	95	4000	80/90	100	120
S10WXX-283560-024DMX-120S-MY3-5X10	24	19	120	1728	90	6000	80/90	100	120

*The strip light will come with 5 meters /reel
*All the data above is just for reference under IP20. it is different with IP65, IP66, IP67, IP68



2835 WHITE COLOR 240LED DMX STRIP

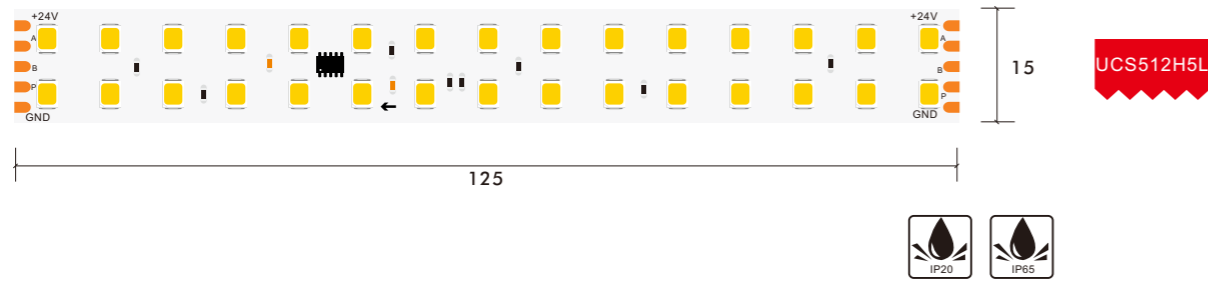

15mm 2835 240LED White Color 8pixels Dmx Strip

Model Number	Voltage (dc v)	Power (w)	LED Qty (pcs)	Lumens (lm/m)	Efficacy (lm/W)	CCT&Color (K)	CRI	Cutting unit (mm)	Bean Angle (o)
S15WXX-283527-024DMX-240D-MY3-5X08	24	17	240	1445	85	2700	80/90	125	120
S15WXX-283530-024DMX-240D-MY3-5X08	24	17	240	1530	90	3000	80/90	125	120
S15WXX-283540-024DMX-240D-MY3-5X08	24	17	240	1615	95	4000	80/90	125	120
S15WXX-283560-024DMX-240D-MY3-5X08	24	17	240	1530	90	6000	80/90	125	120

*The strip light will come with 5 meters /reel
 *All the data above is just for reference under IP20. it is different with IP65, IP66, IP67, IP68



3527 CCT DUAL COLOR 120LED DMX STRIP

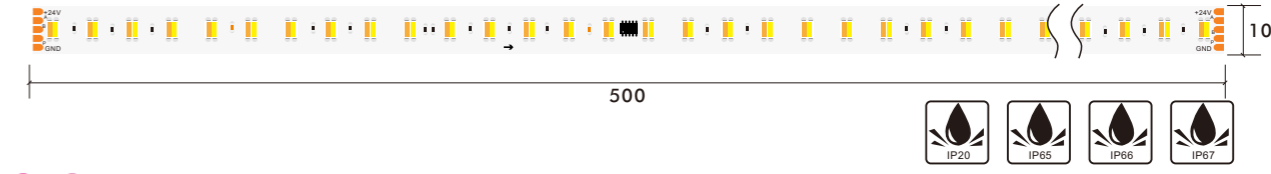
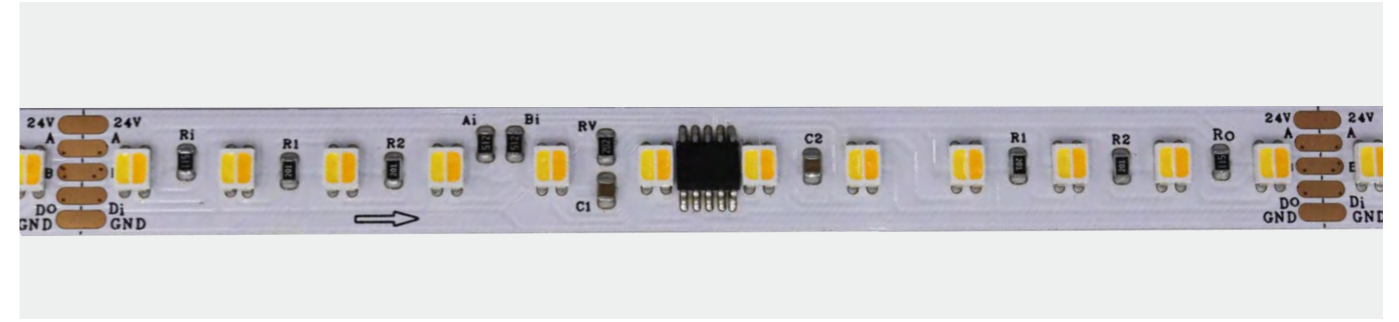

10mm 3527 120LED CCT Color 2pixels Dmx Strip

Model Number	Voltage (dc v)	Power (w)	LED Qty (pcs)	Lumens (lm/m)	Efficacy (lm/W)	CCT&Color (K)	CRI	Cutting unit (mm)	Bean Angle (o)
S10WXX-3527TW-024DMX-120S-MY3-5X02	24	19	120	1520	80	CCT	80/90	500	120

*The strip light will come with 5 meters /reel
 *All the data above is just for reference under IP20. it is different with IP65, IP66, IP67, IP68

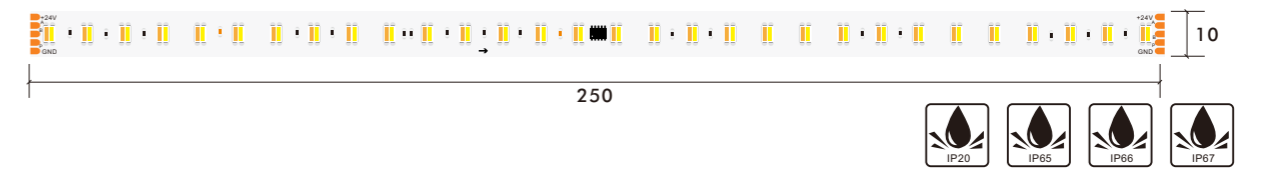

10mm 3527 120LED CCT Color 4pixels Dmx Strip

Model Number	Voltage (dc v)	Power (w)	LED Qty (pcs)	Lumens (lm/m)	Efficacy (lm/W)	CCT&Color (K)	CRI	Cutting unit (mm)	Bean Angle (o)
S10WXX-3527TW-024DMX-120S-MY3-5X04	24	10.3	120	850	80	CCT	80/90	250	120

*The strip light will come with 5 meters /reel
 *All the data above is just for reference under IP20. it is different with IP65, IP66, IP67, IP68

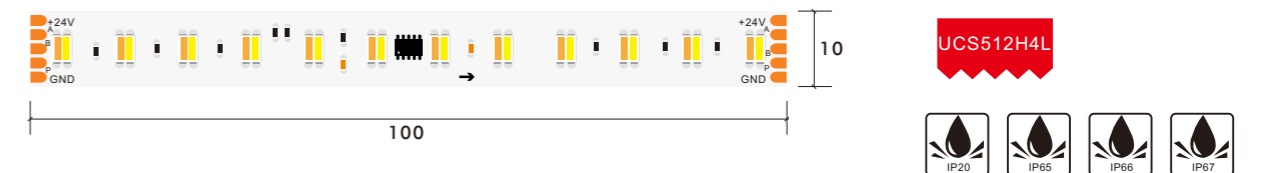

10mm 3527 120LED CCT Color 10pixels Dmx Strip

Model Number	Voltage (dc v)	Power (w)	LED Qty (pcs)	Lumens (lm/m)	Efficacy (lm/W)	CCT&Color (K)	CRI	Cutting unit (mm)	Bean Angle (o)
S10WXX-3527TW-024DMX-120S-MY3-5X10	24	19	120	1520	80	CCT	80/90	100	120

*The strip light will come with 5 meters /reel
 *All the data above is just for reference under IP20. it is different with IP65, IP66, IP67, IP68

5050 RGB COLOR 10/12MM 60LED DMX STRIP

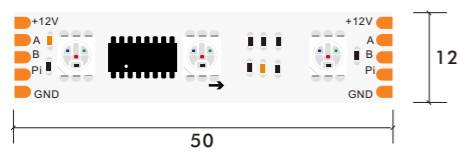
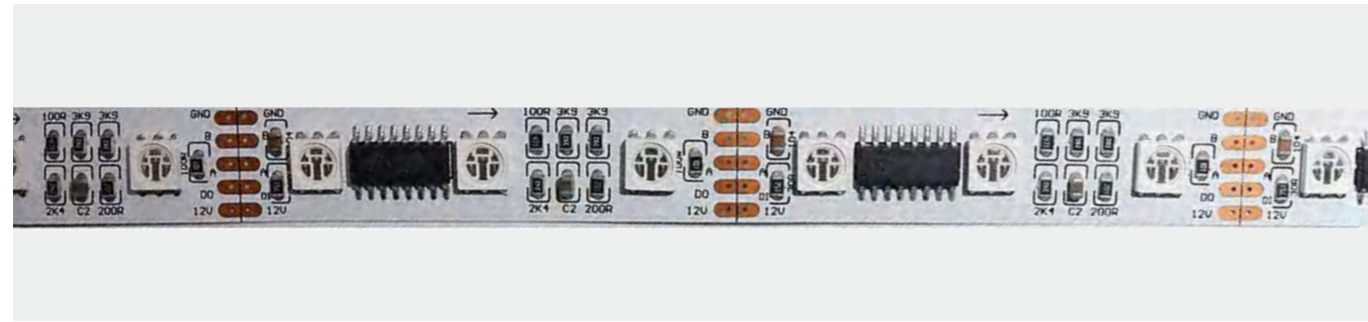

UCS512C4 UCS512H4L



12mm 5050 60LED RGB Color 20pixels Dmx Strip

Model Number	Voltage (dc v)	Power (w)	LED Qty (pcs)	Lumens (lm/m)	Efficacy (lm/W)	CCT&Color (K)	CRI	Cutting unit (mm)	Bean Angle (o)
S12WXX-5050TC-012DMX-060S-MY3-5X20	12	14.4	60	N/A	N/A	RGB	N/A	50	120

*The strip light will come with 5 meters /reel
 *All the data above is just for reference under IP20. it is different with IP65, IP66, IP67, IP68

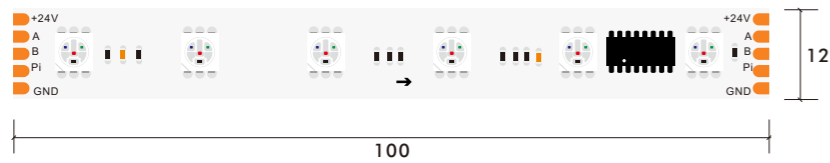

UCS512C4 UCS512H4L



12mm 5050 60LED RGB Color 10pixels Dmx Strip

Model Number	Voltage (dc v)	Power (w)	LED Qty (pcs)	Lumens (lm/m)	Efficacy (lm/W)	CCT&Color (K)	CRI	Cutting unit (mm)	Bean Angle (o)
S12WXX-5050TC-024DMX-060S-MY3-5X10	24	14.4	60	N/A	N/A	RGB	N/A	100	120

*The strip light will come with 5 meters /reel
 *All the data above is just for reference under IP20. it is different with IP65, IP66, IP67, IP68

2835 RGB COLOR 120LED DMX STRIP

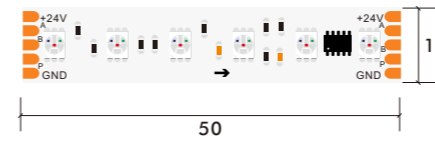
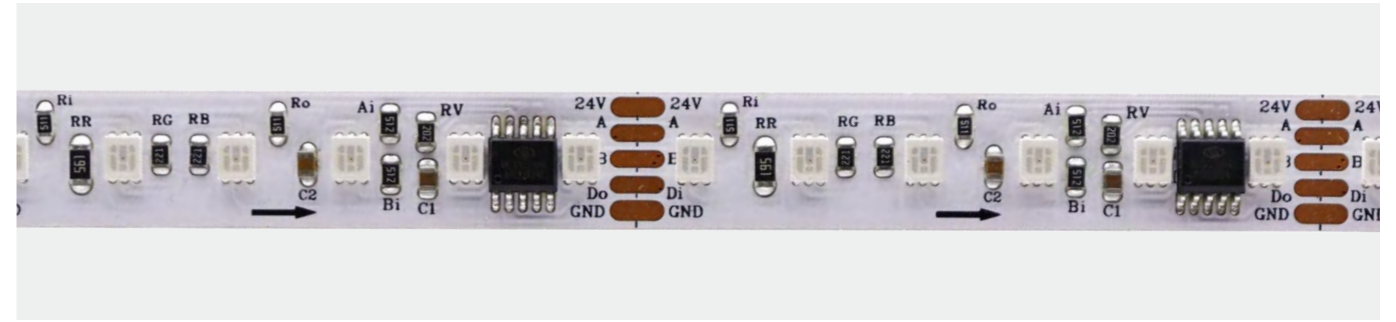

UCS512H4L



10mm 2835 120LED RGB Color 20pixels Dmx Strip

Model Number	Voltage (dc v)	Power (w)	LED Qty (pcs)	Lumens (lm/m)	Efficacy (lm/W)	CCT&Color (K)	CRI	Cutting unit (mm)	Bean Angle (o)
S10WXX-2835TC-024DMX-120S-MY3-5X20	24	14	120	N/A	N/A	RGB	N/A	50	120

*The strip light will come with 5 meters /reel
 *All the data above is just for reference under IP20. it is different with IP65, IP66, IP67, IP68

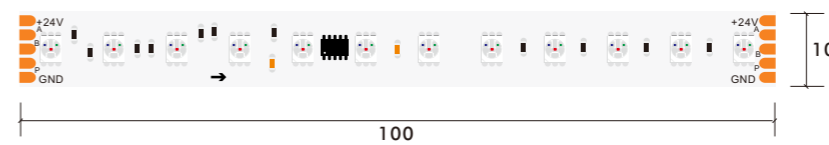

UCS512H5L



10mm 2835 120LED RGB Color 10pixels Dmx Strip

Model Number	Voltage (dc v)	Power (w)	LED Qty (pcs)	Lumens (lm/m)	Efficacy (lm/W)	CCT&Color (K)	CRI	Cutting unit (mm)	Bean Angle (o)
S10WXX-2835TC-024DMX-120S-MY3-5X10	24	21	120	N/A	N/A	RGB	N/A	100	120

*The strip light will come with 5 meters /reel
 *All the data above is just for reference under IP20. it is different with IP65, IP66, IP67, IP68

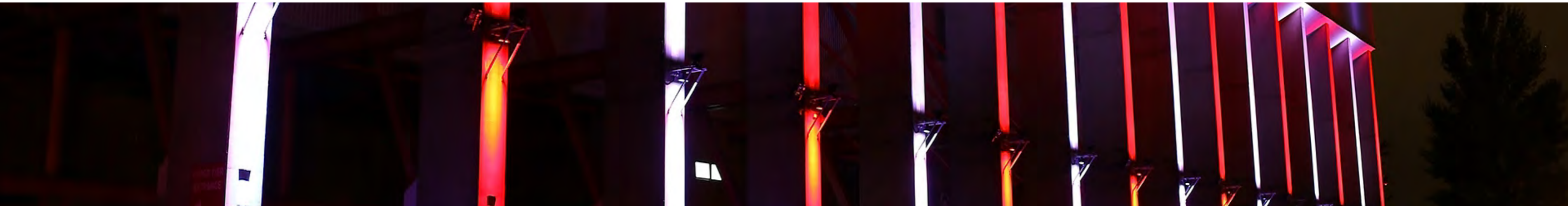

5050 RGBW COLOR 12MM 60LED DMX STRIP

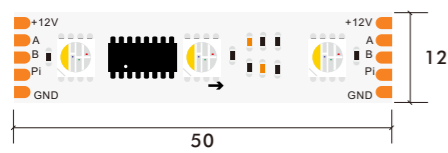
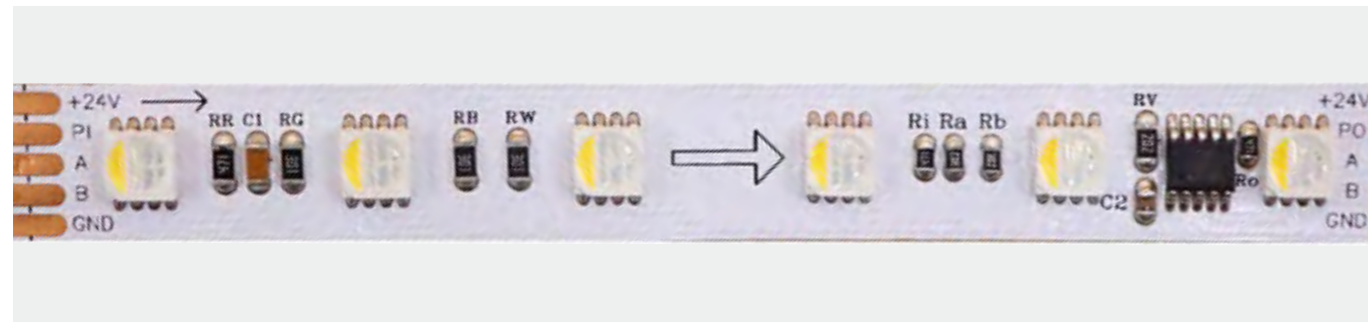

UCS512C4 UCS512H4L



Model Number	Voltage (dc v)	Power (w)	LED Qty (pcs)	Lumens (lm/m)	Efficacy (lm/W)	CCT&Color (K)	CRI	Cutting unit (mm)	Bean Angle (o)
S12WXX-5050MC-012DMX-060S-MY3-5X20	12	18	60	N/A	N/A	RGBW	80/90	50	120

*The strip light will come with 5 meters /reel
 *All the data above is just for reference under IP20. it is different with IP65, IP66, IP67, IP68

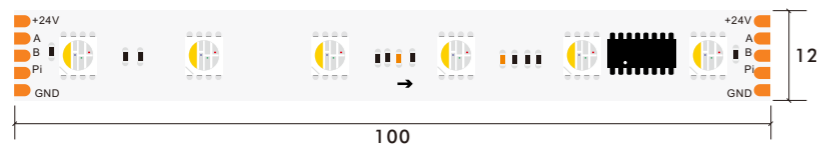

UCS512C4 UCS512H4L



Model Number	Voltage (dc v)	Power (w)	LED Qty (pcs)	Lumens (lm/m)	Efficacy (lm/W)	CCT&Color (K)	CRI	Cutting unit (mm)	Bean Angle (o)
S12WXX-5050MC-024DMX-060S-MY3-5X10	24	18	60	N/A	N/A	RGBW	80/90	100	120

*The strip light will come with 5 meters /reel
 *All the data above is just for reference under IP20. it is different with IP65, IP66, IP67, IP68

5050 RGBW COLOR 12MM 84LED DMX STRIP

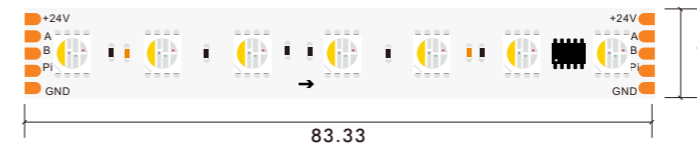
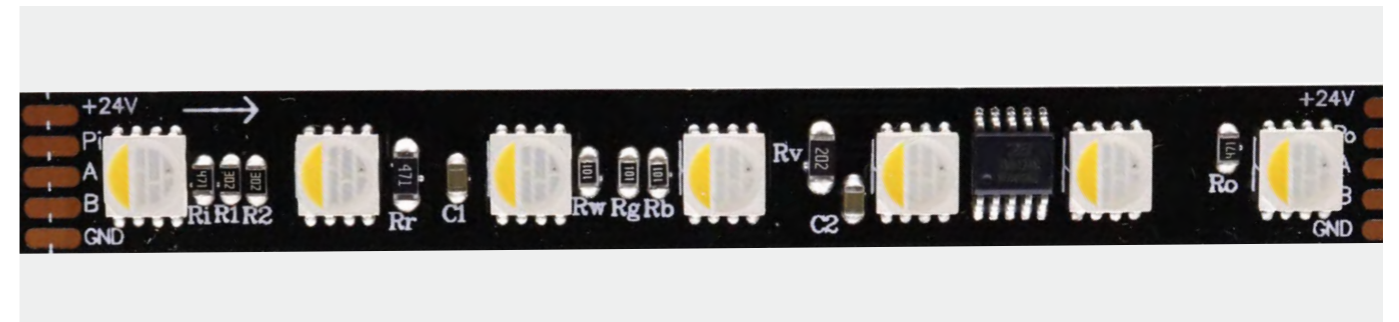

UCS512H4L



Model Number	Voltage (dc v)	Power (w)	LED Qty (pcs)	Lumens (lm/m)	Efficacy (lm/W)	CCT&Color (K)	CRI	Cutting unit (mm)	Bean Angle (o)
S12WXX-5050MC-024DMX-084S-MY3-5X12	24	27.4	84	N/A	N/A	RGBW	80/90	83.3	120

*The strip light will come with 5 meters /reel
 *All the data above is just for reference under IP20. it is different with IP65, IP66, IP67, IP68

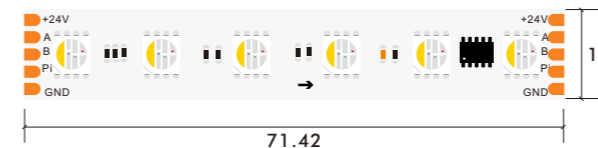

UCS512H4L



Model Number	Voltage (dc v)	Power (w)	LED Qty (pcs)	Lumens (lm/m)	Efficacy (lm/W)	CCT&Color (K)	CRI	Cutting unit (mm)	Bean Angle (o)
S12WXX-5050MC-024DMX-084S-MY3-5X14	24	27.7	84	N/A	N/A	RGBW	80/90	71.42	120

*The strip light will come with 5 meters /reel
 *All the data above is just for reference under IP20. it is different with IP65, IP66, IP67, IP68

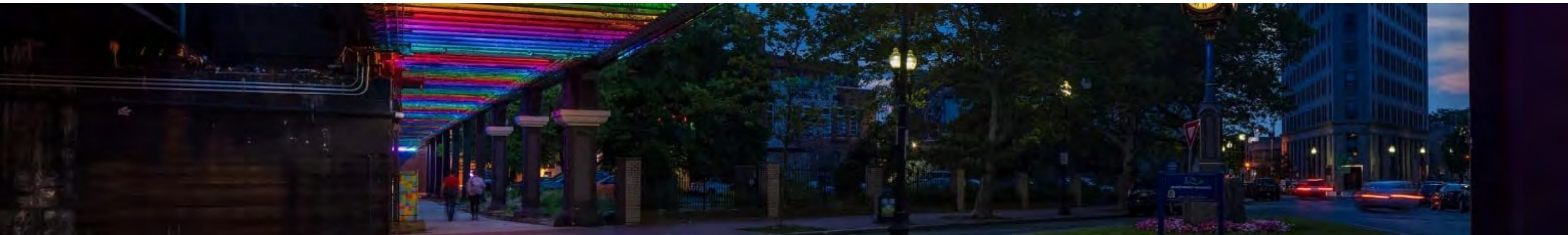

5050 RGBW COLOR 12MM 96LED DMX STRIP

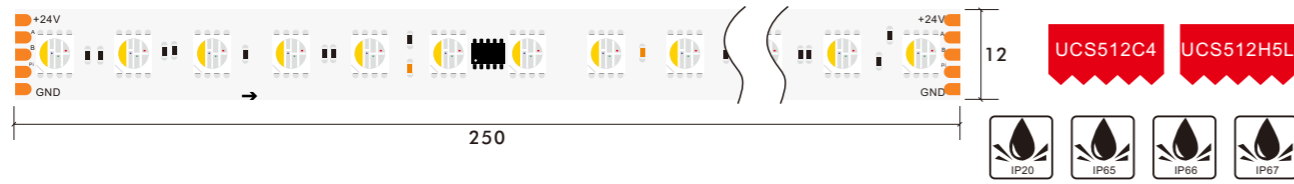
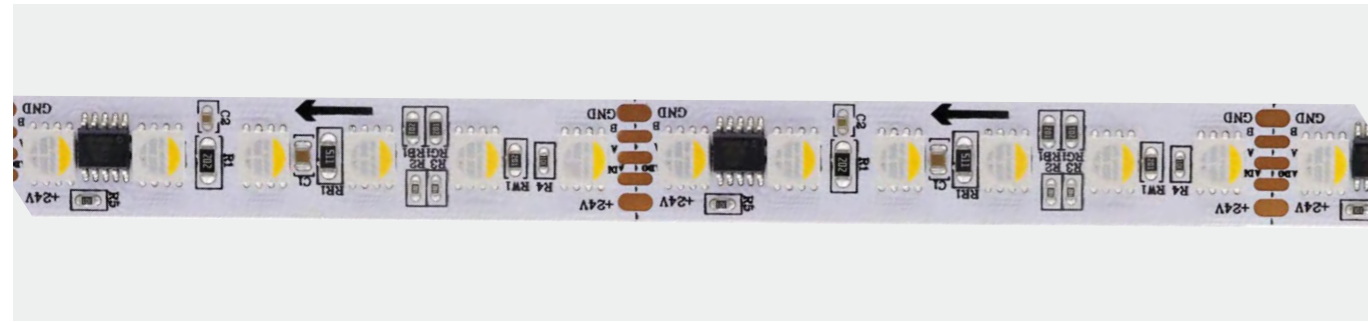

24V DC 4 Pixel 5 Line 12mm 5050 96LED RGBW Color 4pixels Dmx Strip

Model Number	Voltage (dc v)	Power (w)	LED Qty (pcs)	Lumens (lm/m)	Efficacy (lm/W)	CCT&Color (K)	CRI	Cutting unit (mm)	Bean Angle (o)
S12WXX-5050MC-024DMX-096S-MY3-5X04	24	10	96	N/A	N/A	RGBW	N/A	250	120

*The strip light will come with 5 meters /reel
 *All the data above is just for reference under IP20. it is different with IP65, IP66, IP67, IP68

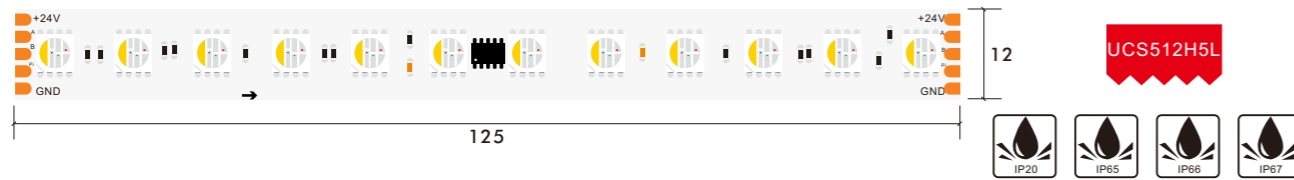

24V DC 8 Pixel 5 Line 12mm 5050 96LED RGBW Color 8pixels Dmx Strip

Model Number	Voltage (dc v)	Power (w)	LED Qty (pcs)	Lumens (lm/m)	Efficacy (lm/W)	CCT&Color (K)	CRI	Cutting unit (mm)	Bean Angle (o)
S12WXX-5050MC-024DMX-096S-MY3-5X08	24	21	N/A	N/A	80	RGBW	N/A	125	120

*The strip light will come with 5 meters /reel
 *All the data above is just for reference under IP20. it is different with IP65, IP66, IP67, IP68



24V DC 16 Pixel 5 Line 12mm 5050 96LED RGBW Color 16pixels Dmx Strip

Model Number	Voltage (dc v)	Power (w)	LED Qty (pcs)	Lumens (lm/m)	Efficacy (lm/W)	CCT&Color (K)	CRI	Cutting unit (mm)	Bean Angle (o)
S12WXX-5050MC-024DMX-096S-MY3-5X12	24	30	N/A	N/A	N/A	RGBW	N/A	62.5	120

*The strip light will come with 5 meters /reel
 *All the data above is just for reference under IP20. it is different with IP65, IP66, IP67, IP68

5050 RGBCCT COLOR 12MM 60LED DMX STRIP

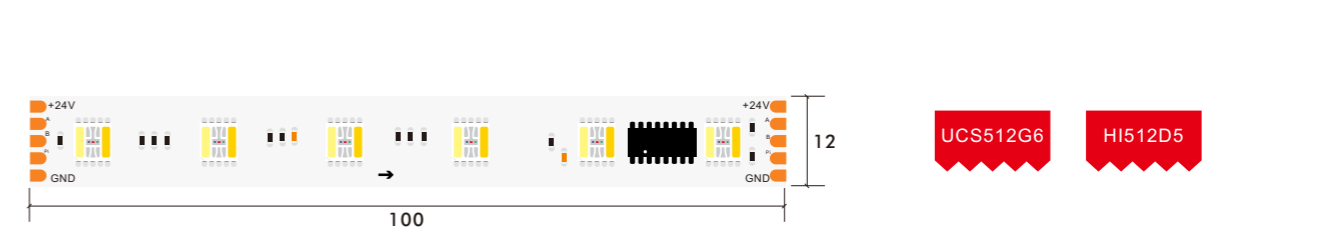
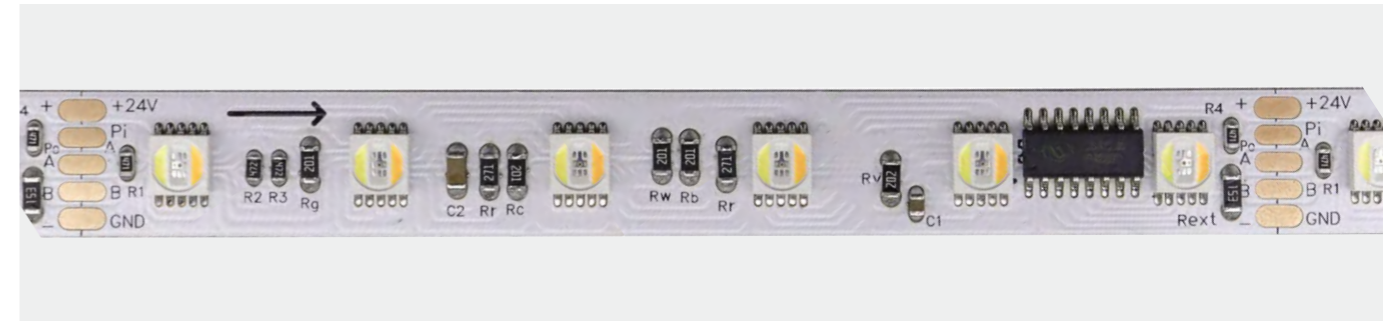

24V DC 10 Pixel 5 Line 12mm 5050 60LED RGBWW Color 10pixels Dmx Strip

Model Number	Voltage (dc v)	Power (w)	LED Qty (pcs)	Lumens (lm/m)	Efficacy (lm/W)	CCT&Color (K)	CRI	Cutting unit (mm)	Bean Angle (o)
S12WXX-5050FC-024DMX-060S-MY3-5X10	24	23	60	N/A	N/A	RGBWW	80/90	50	120

*The strip light will come with 5 meters /reel
 *All the data above is just for reference under IP20. it is different with IP65, IP66, IP67, IP68

